

MUTCD SIGN SCHEDULE

| NO. | SIGN | MOUNTING | MIN. SIZE | MIN. SPACING | COLORS | BACK GRND | LEGEND |
|-----|--------------------|----------|-----------|--------------|-------------|-----------|--------|
| 1 | STOP | R1-1 | 30"x30" | RED | WHITE | (16) | (2530) |
| 2 | YIELD | Y1-1 | 24"x24" | YELLOW/RED | BLACK | (16) | (2530) |
| 3 | NO PARKING | NY-R7-80 | 12"x18" | WHITE/BLUE | GREEN/WHITE | (16) | (2530) |
| 4 | NO PARKING ANYTIME | R7-80 | 12"x18" | WHITE | BLUE | (16) | (2530) |
| 5 | NO PARKING 7-9 PM | R7-1 | 12"x18" | WHITE | RED | (16) | (2530) |
| 6 | NO PARKING 9-5 PM | R3-2 | 30"x30" | WHITE | BLACK/RED | (16) | (2530) |
| 7 | NO PARKING 6-9 PM | R3-2 | 30"x30" | WHITE | BLACK/RED | (16) | (2530) |
| 8 | NO PARKING 6-9 PM | R15-1 | 48"x9" | WHITE | BLACK | (16) | (2530) |
| 9 | EXEMPT | R15-3P | 24"x12" | WHITE | BLACK | (16) | (2530) |
| 10 | NO STOPPING | W10-1 | 30" | YELLOW | BLACK | (16) | (2530) |
| 11 | CUSTOM | 18"x18" | WHITE | GREEN | (16) | (2530) | |

MUTCD SIGN SCHEDULE
SCALE: NOT TO SCALE

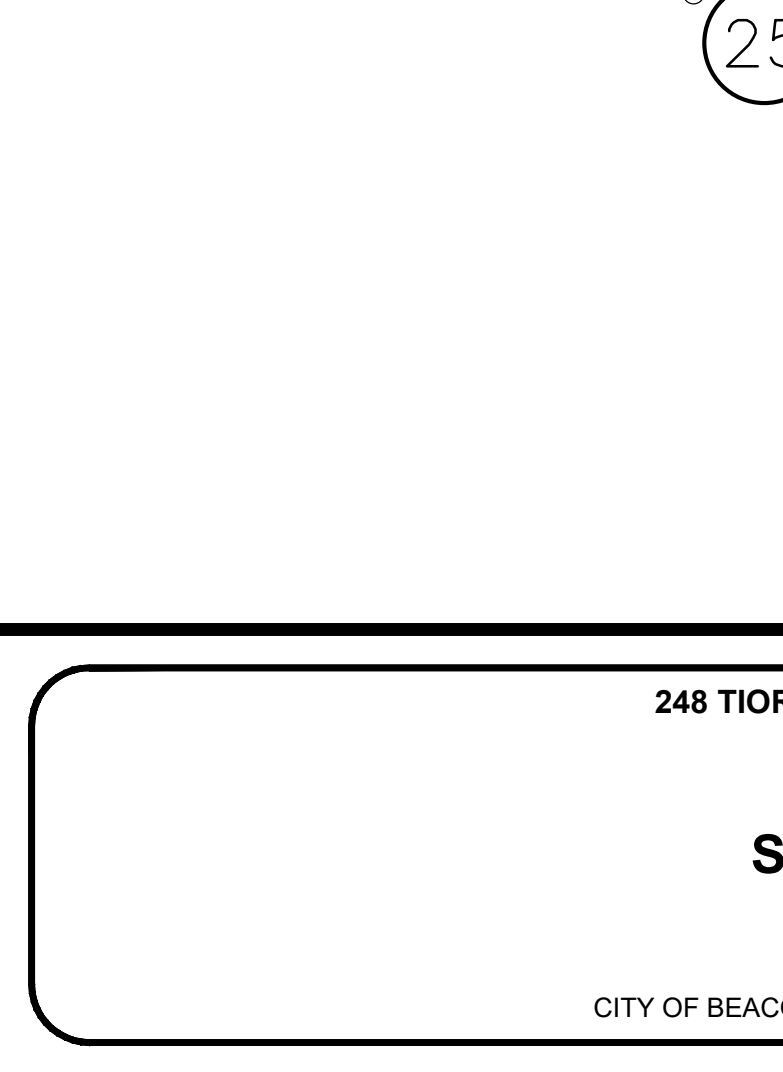
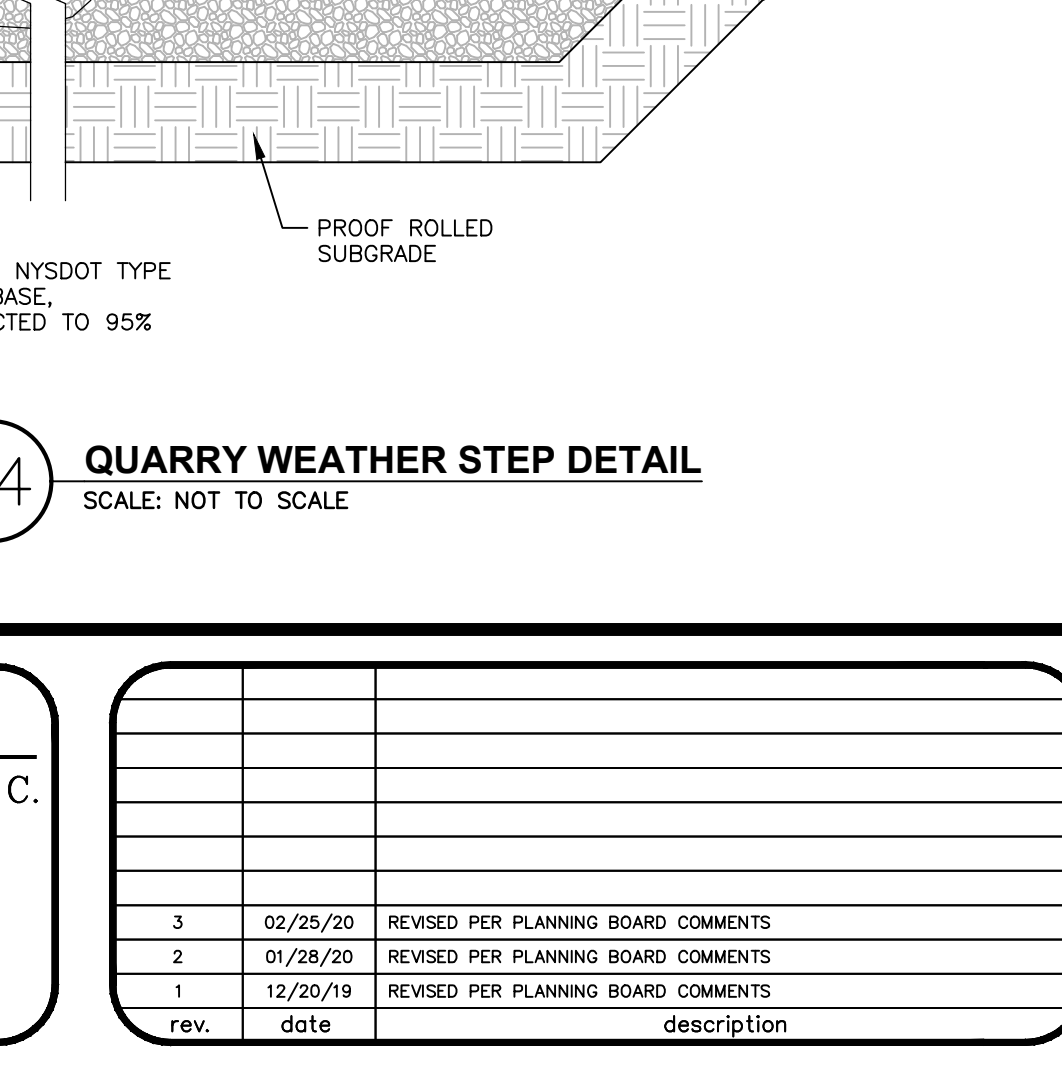
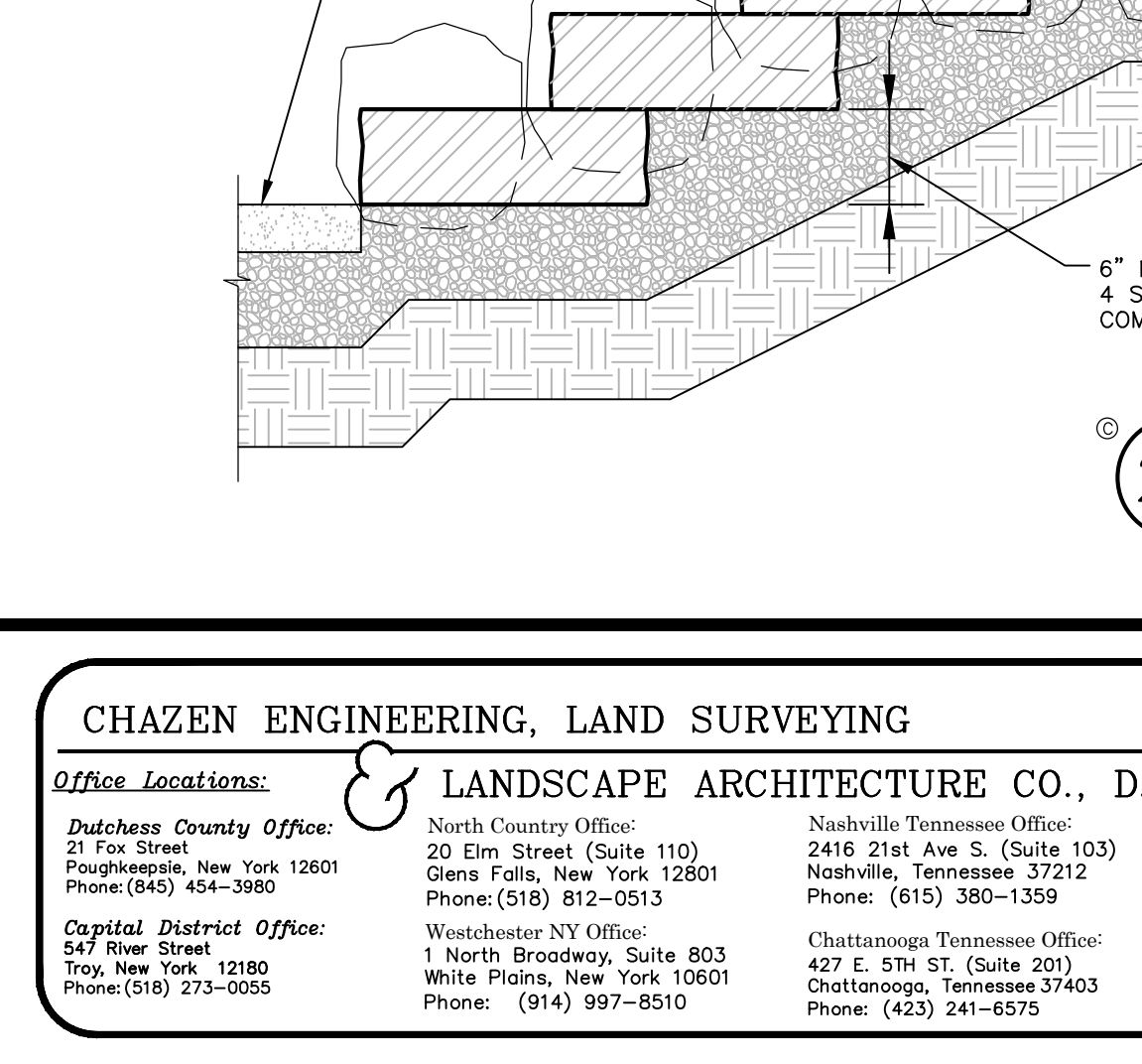
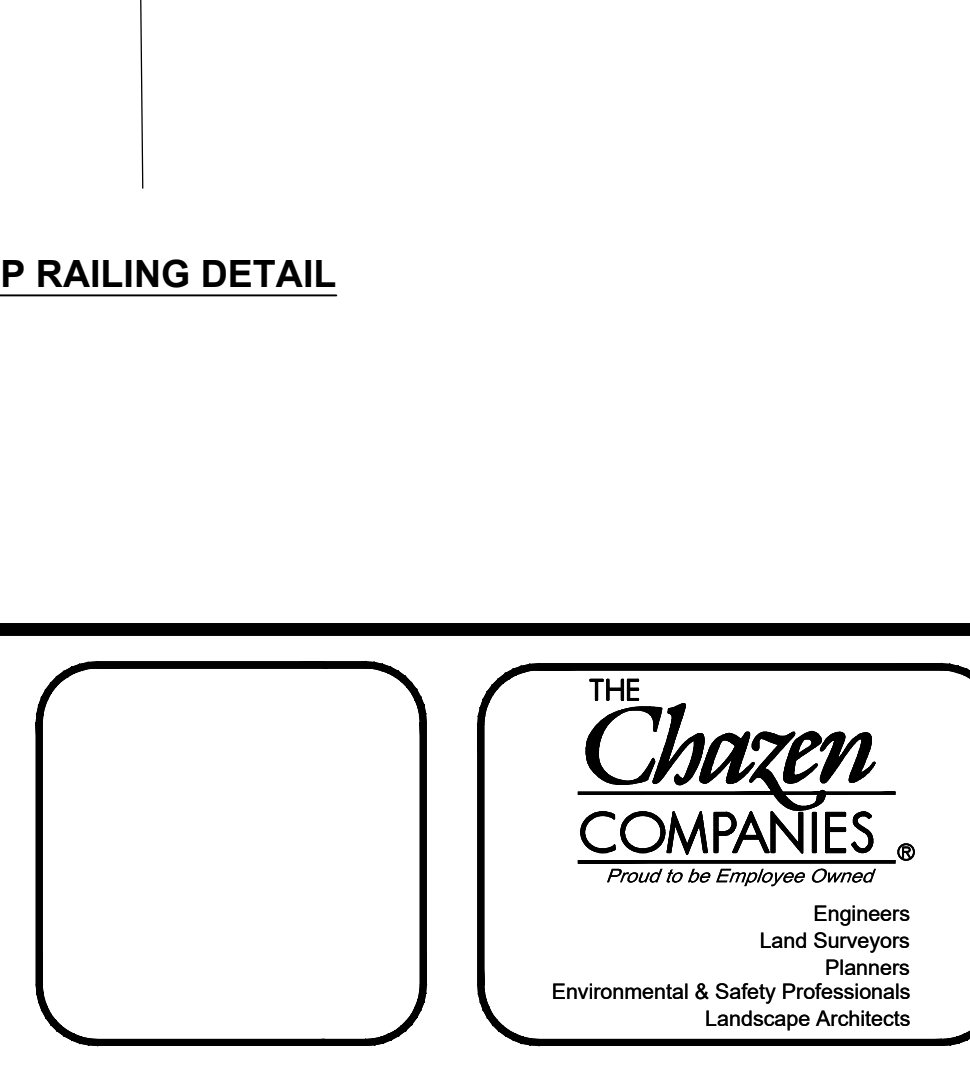
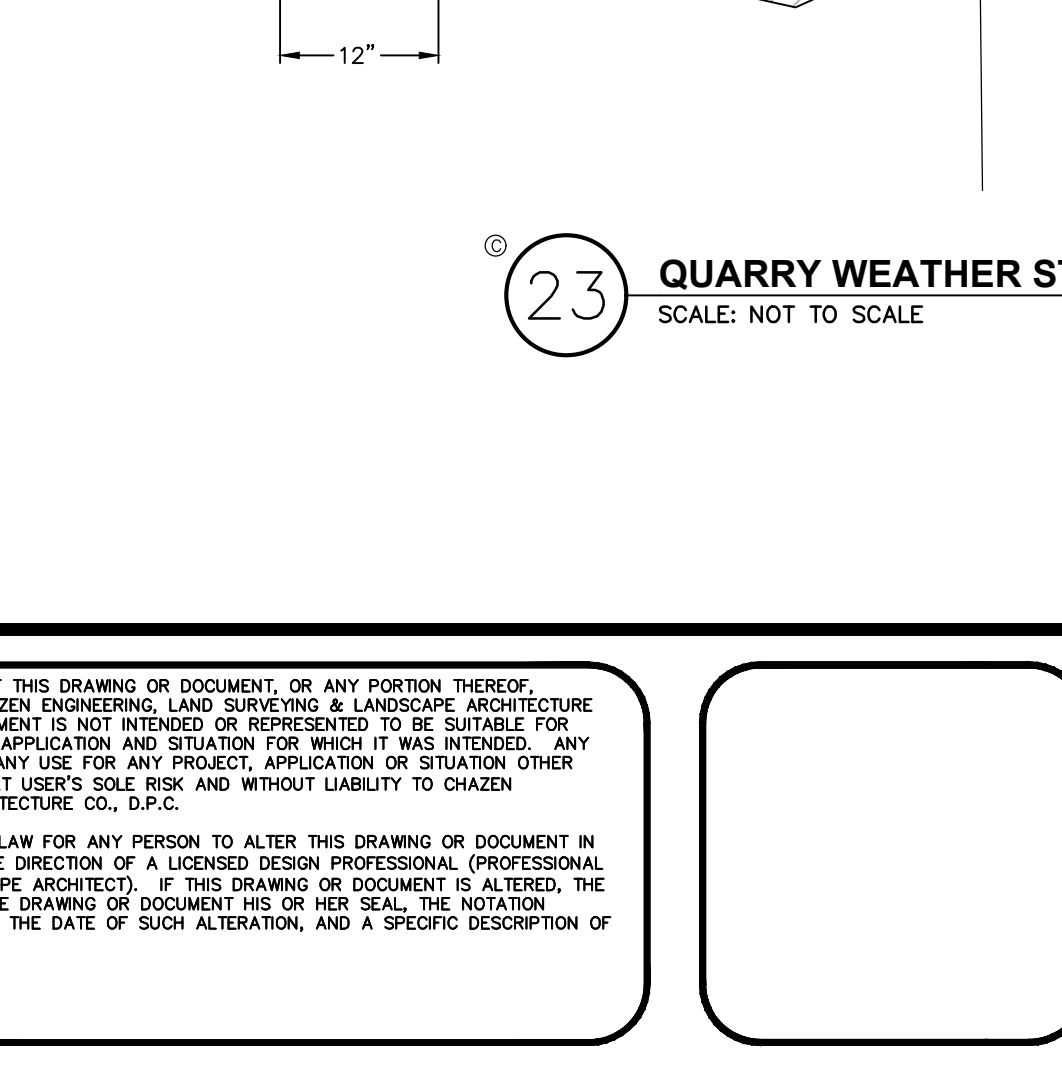
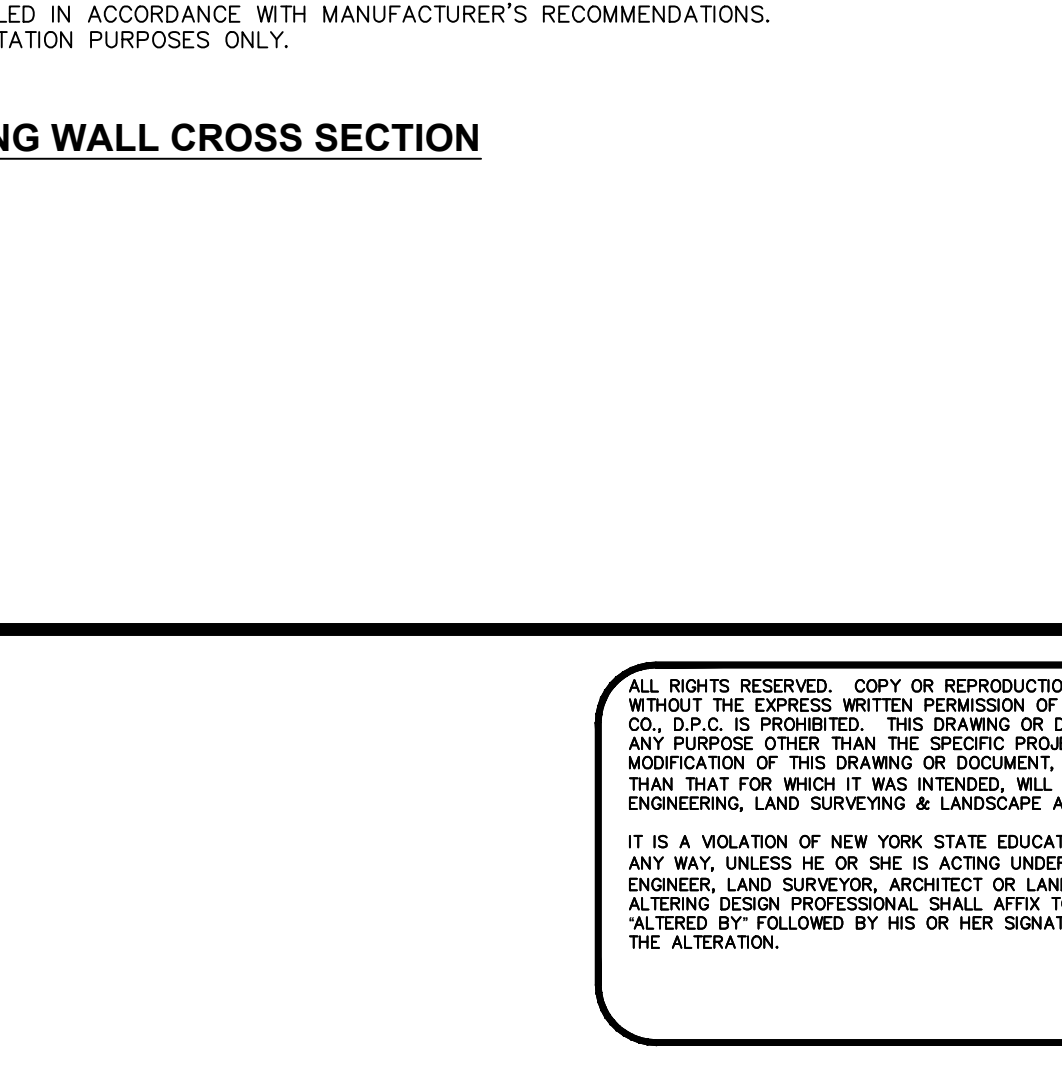
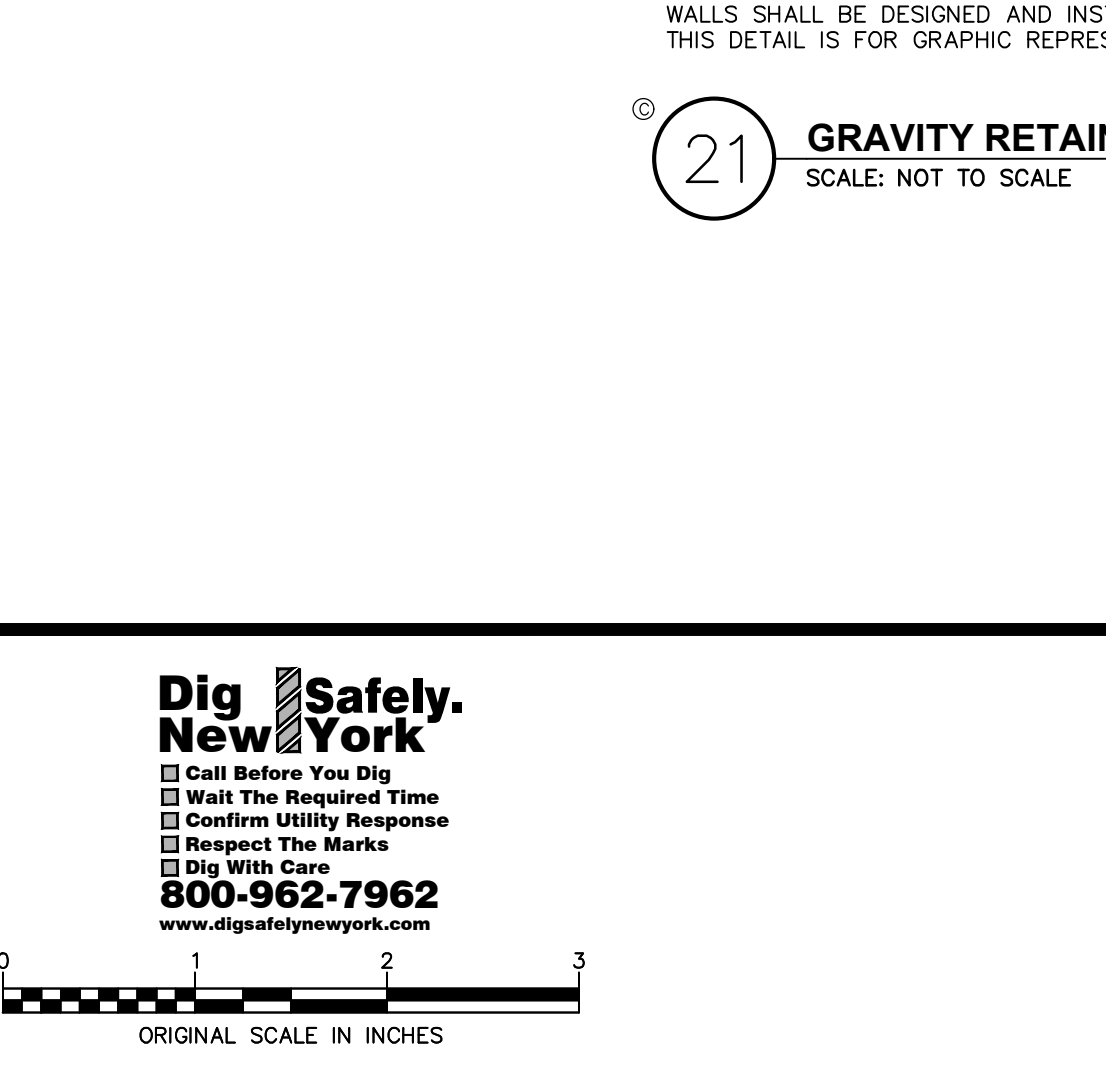
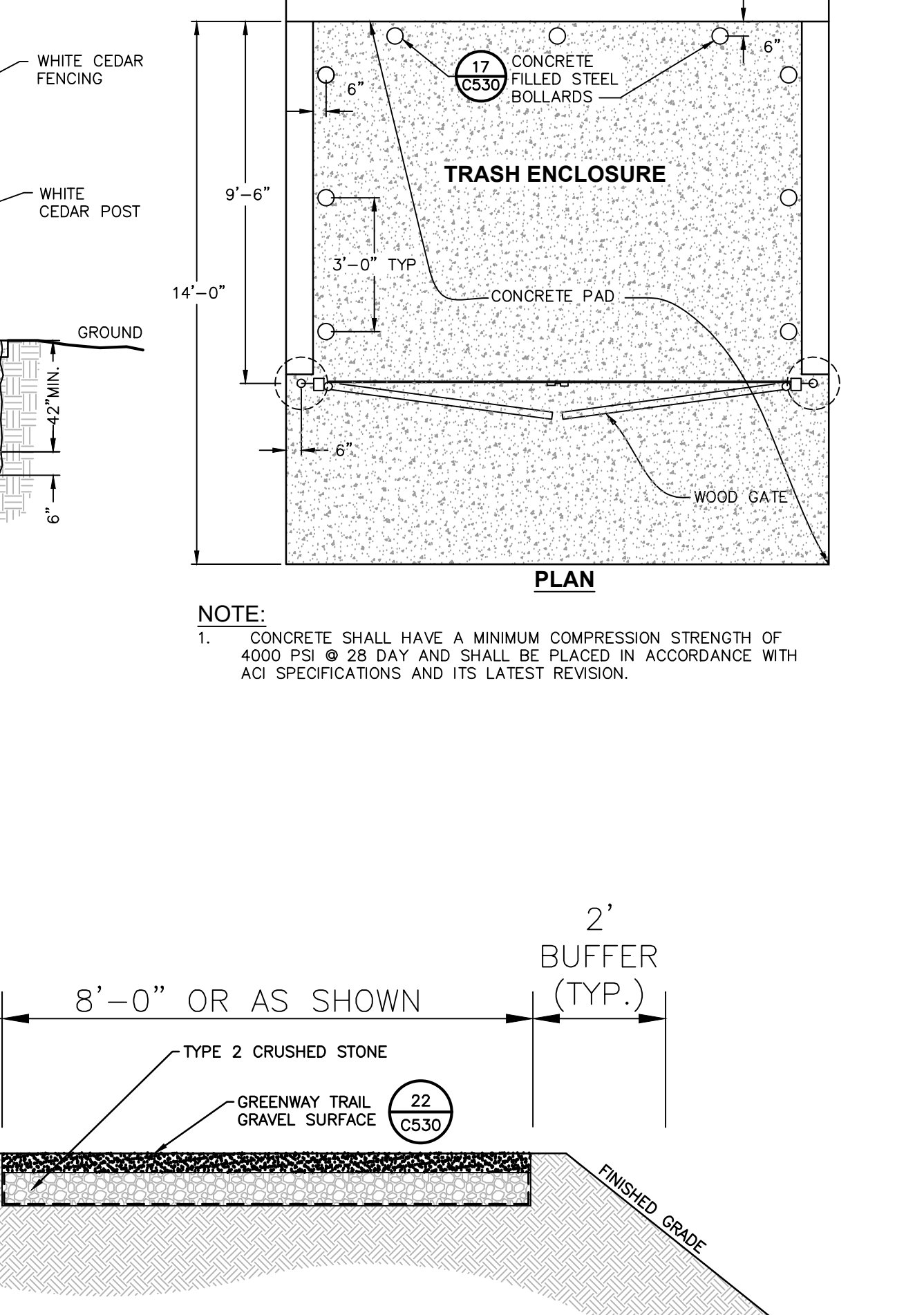
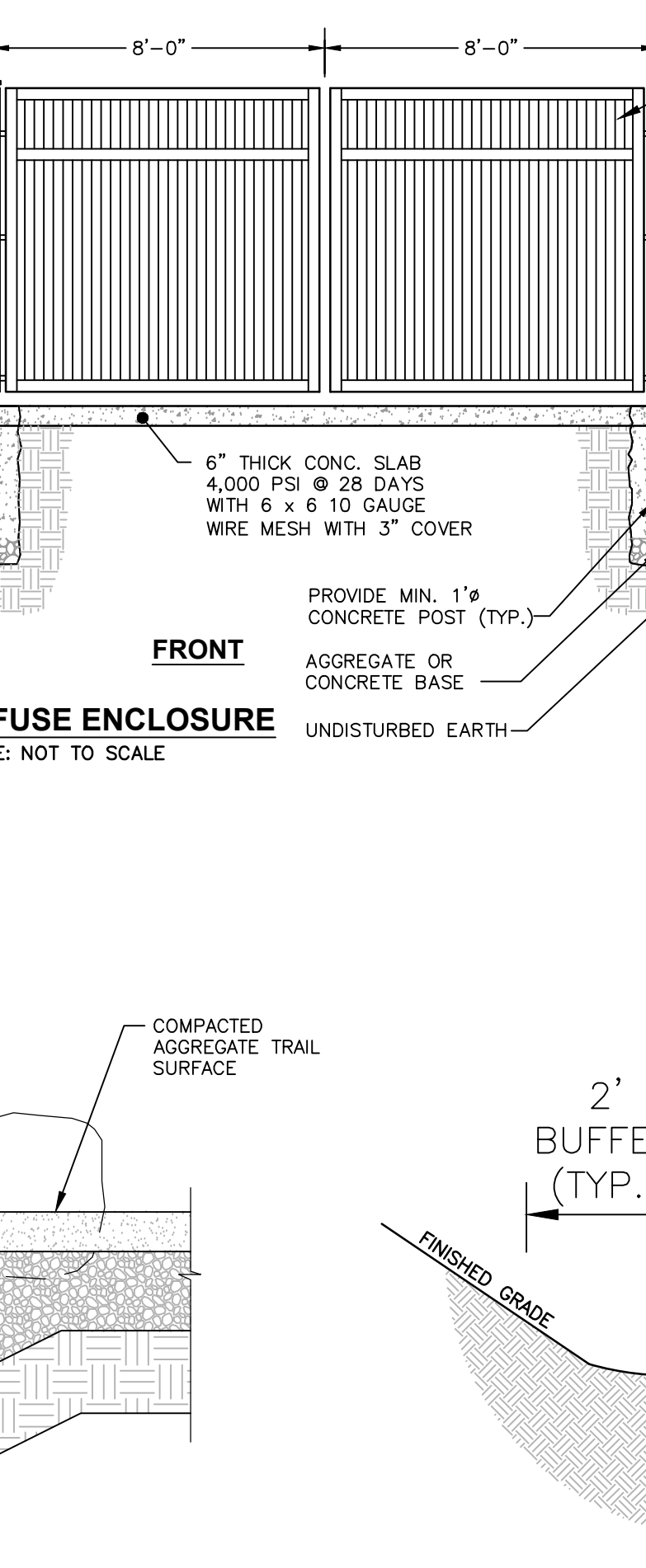
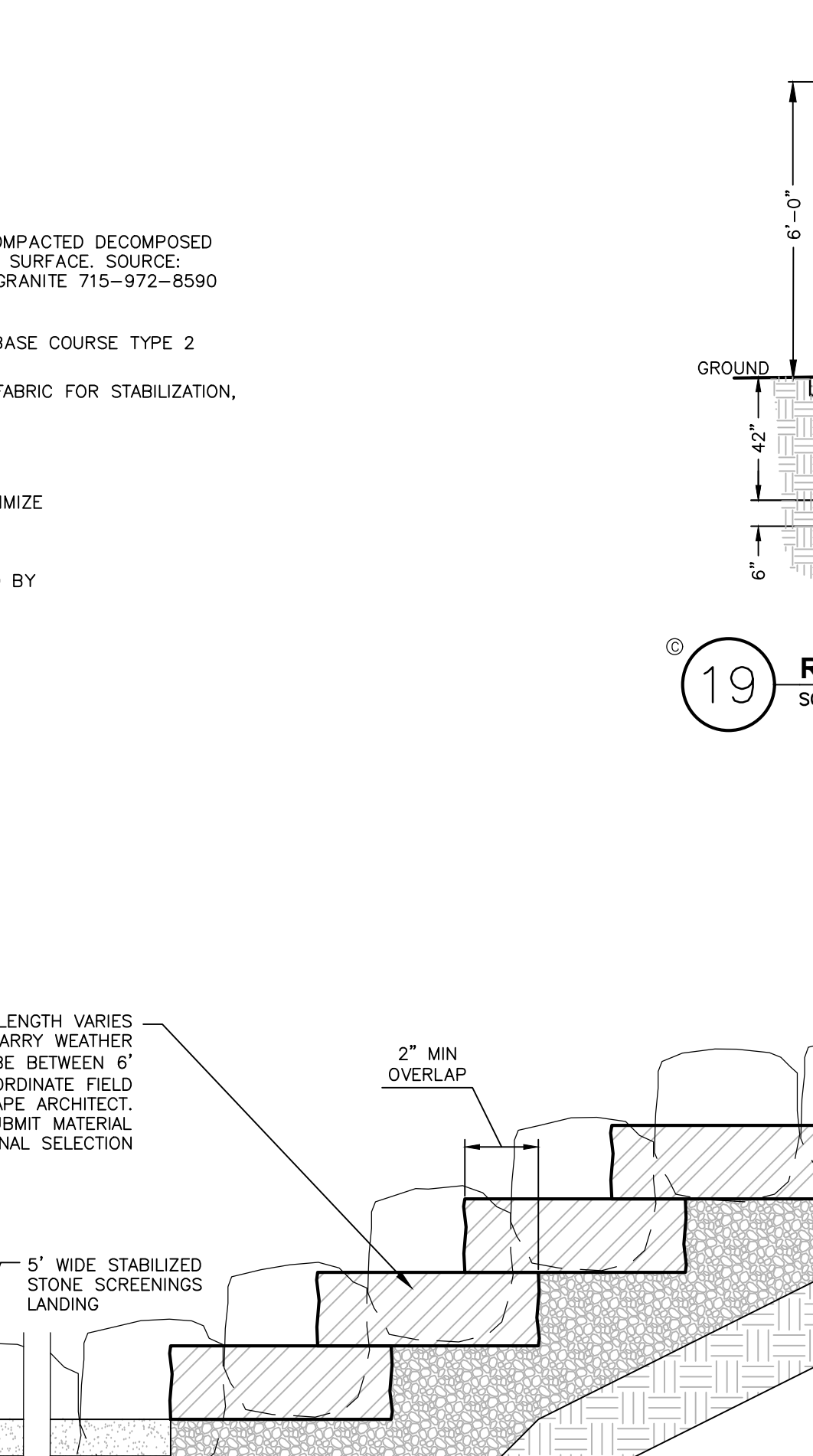
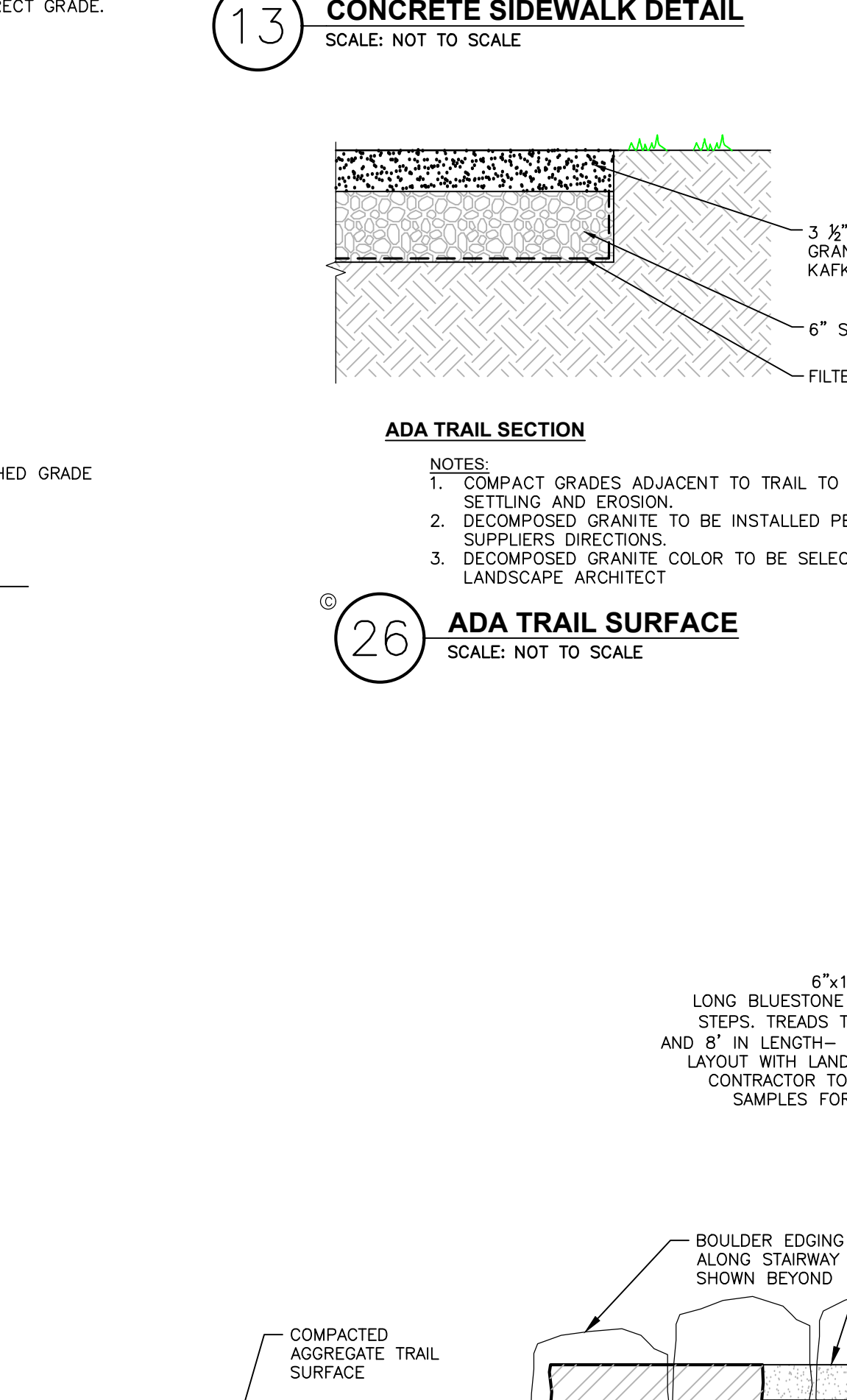
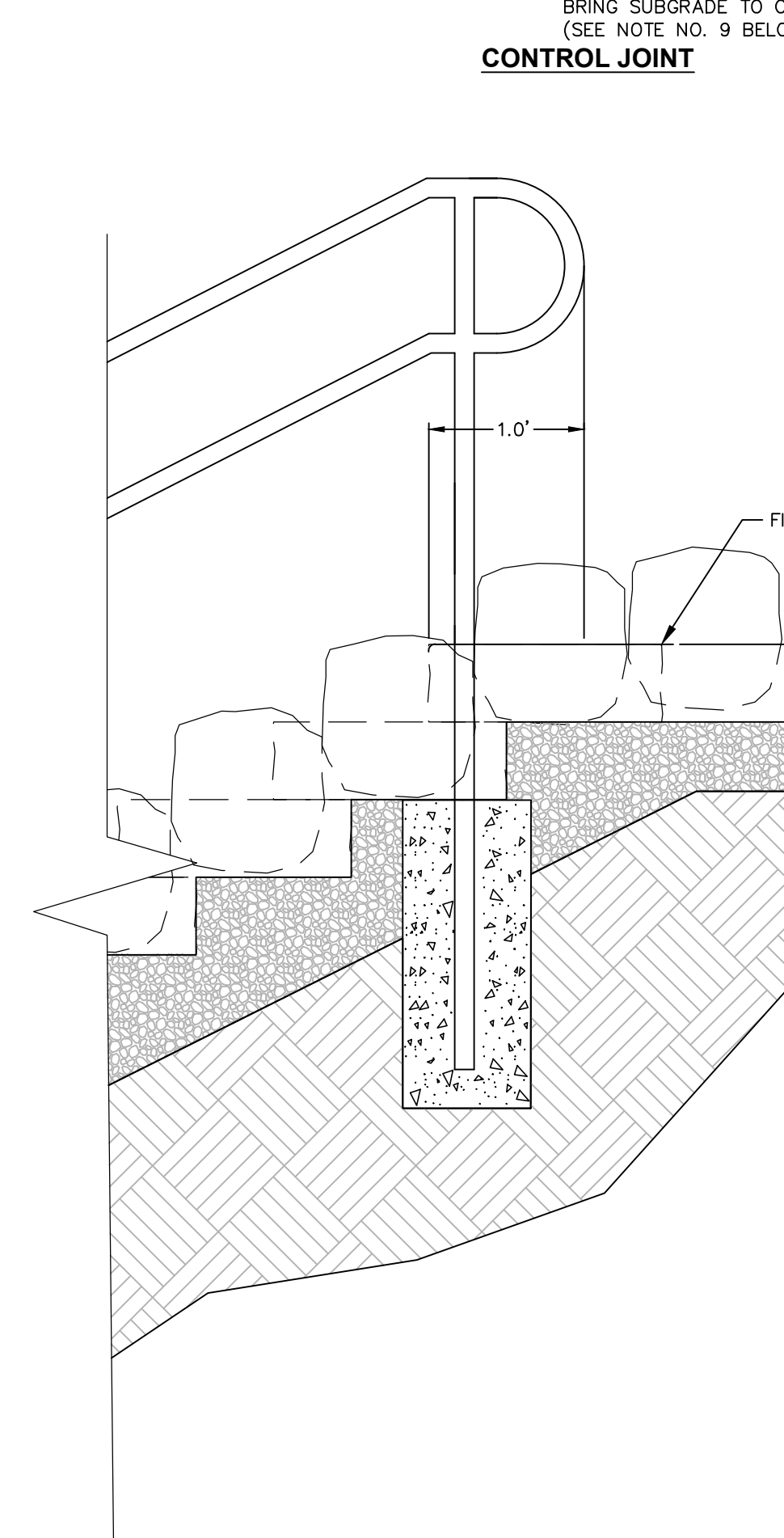
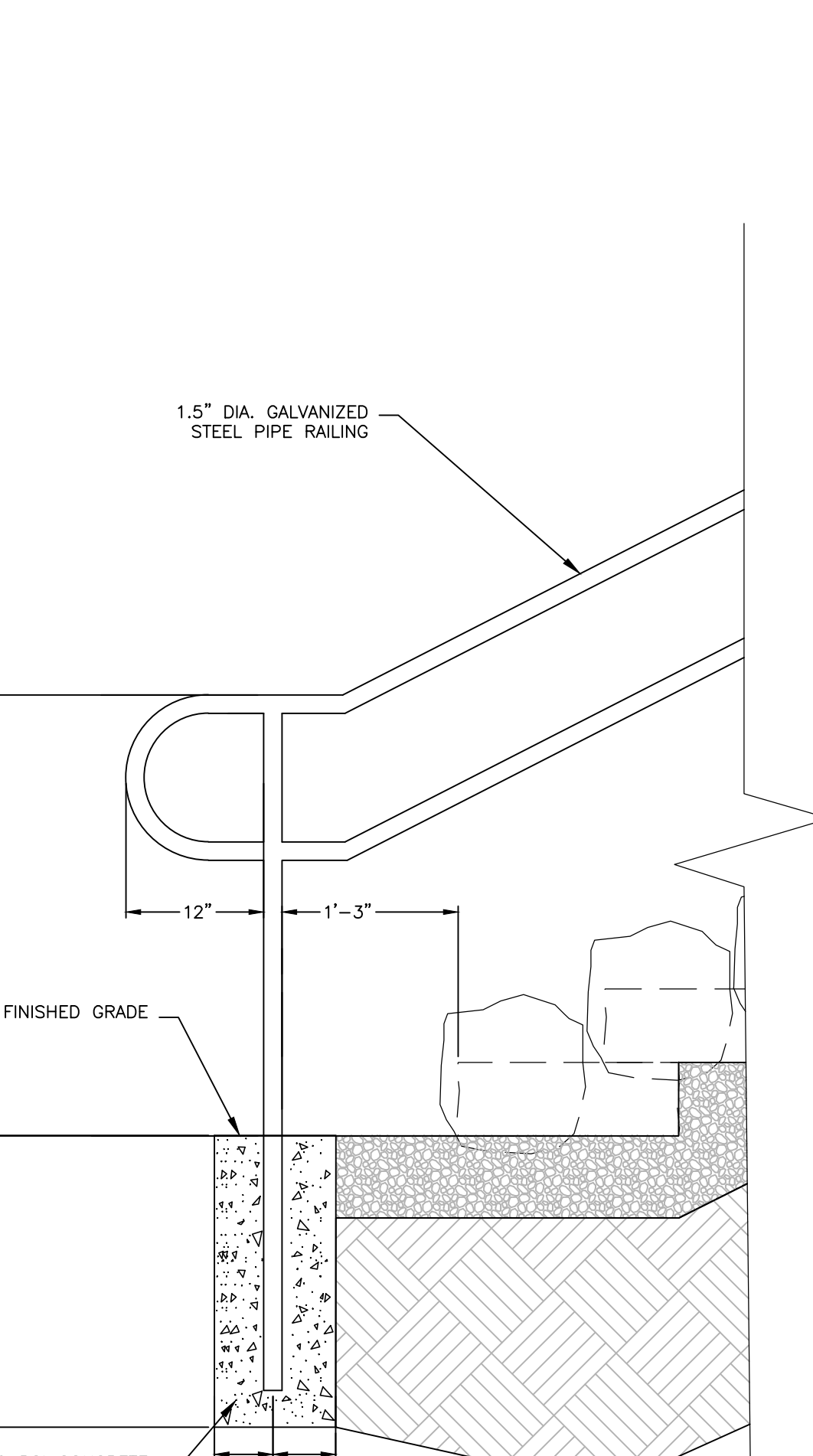
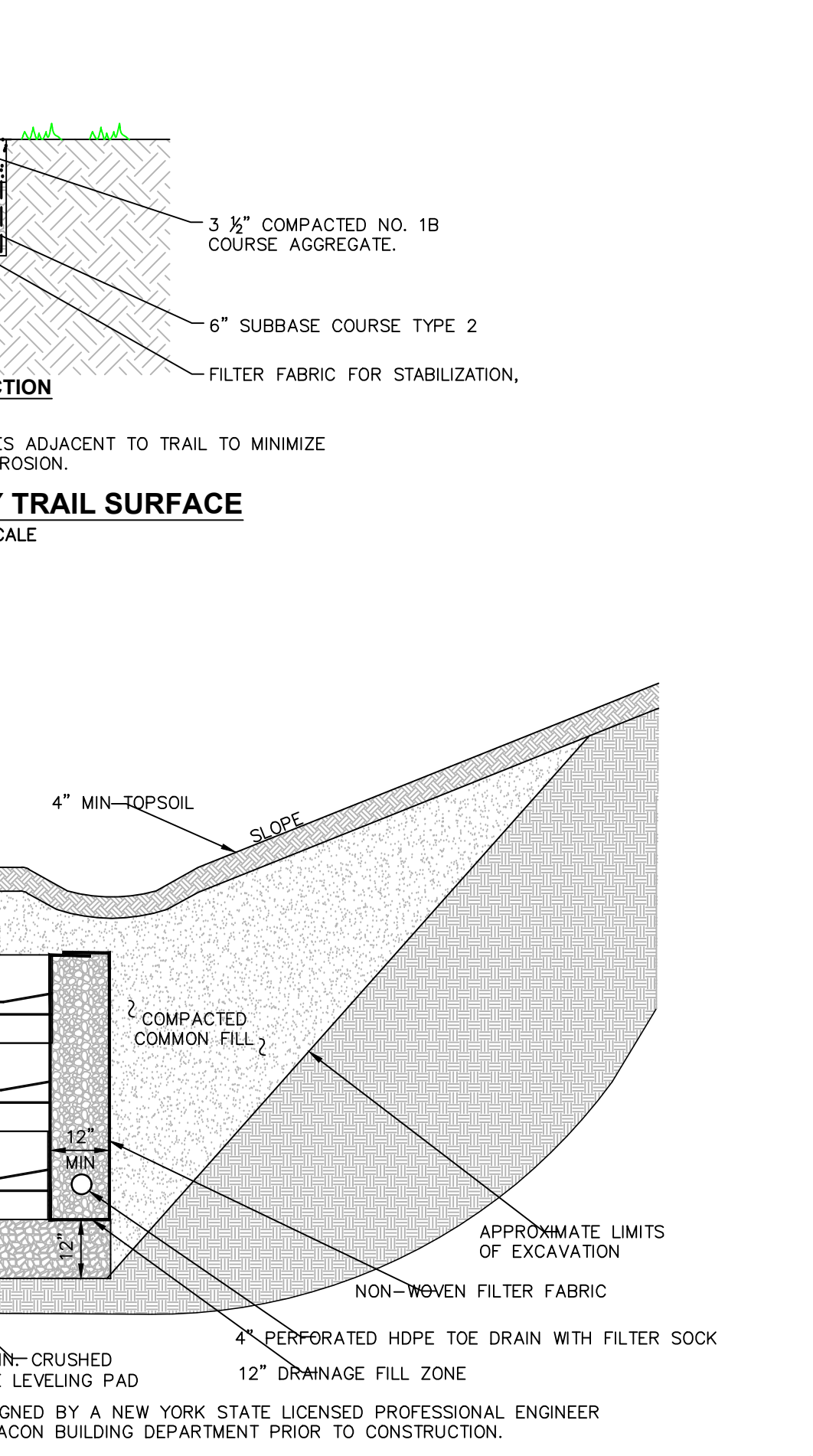
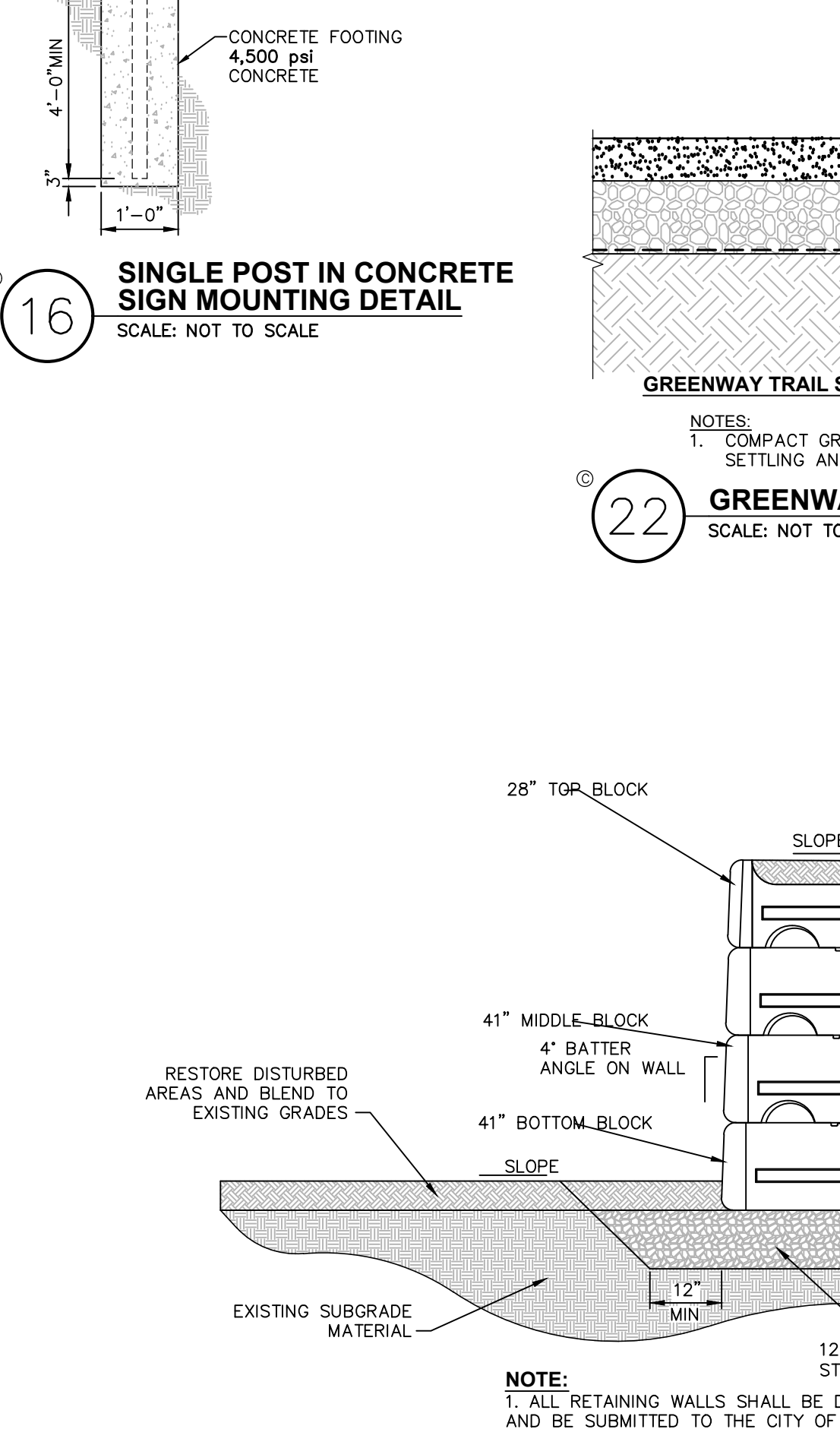
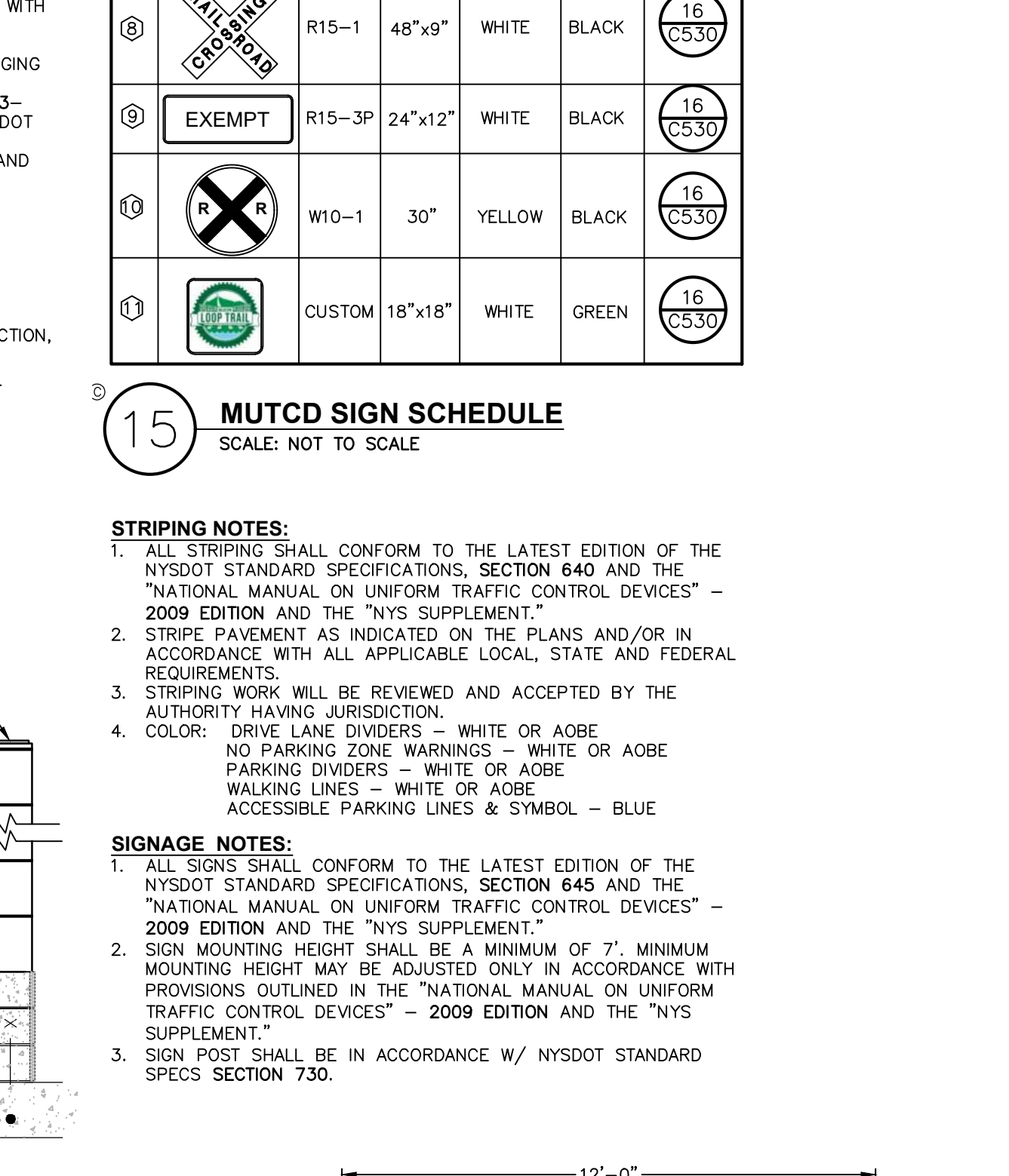
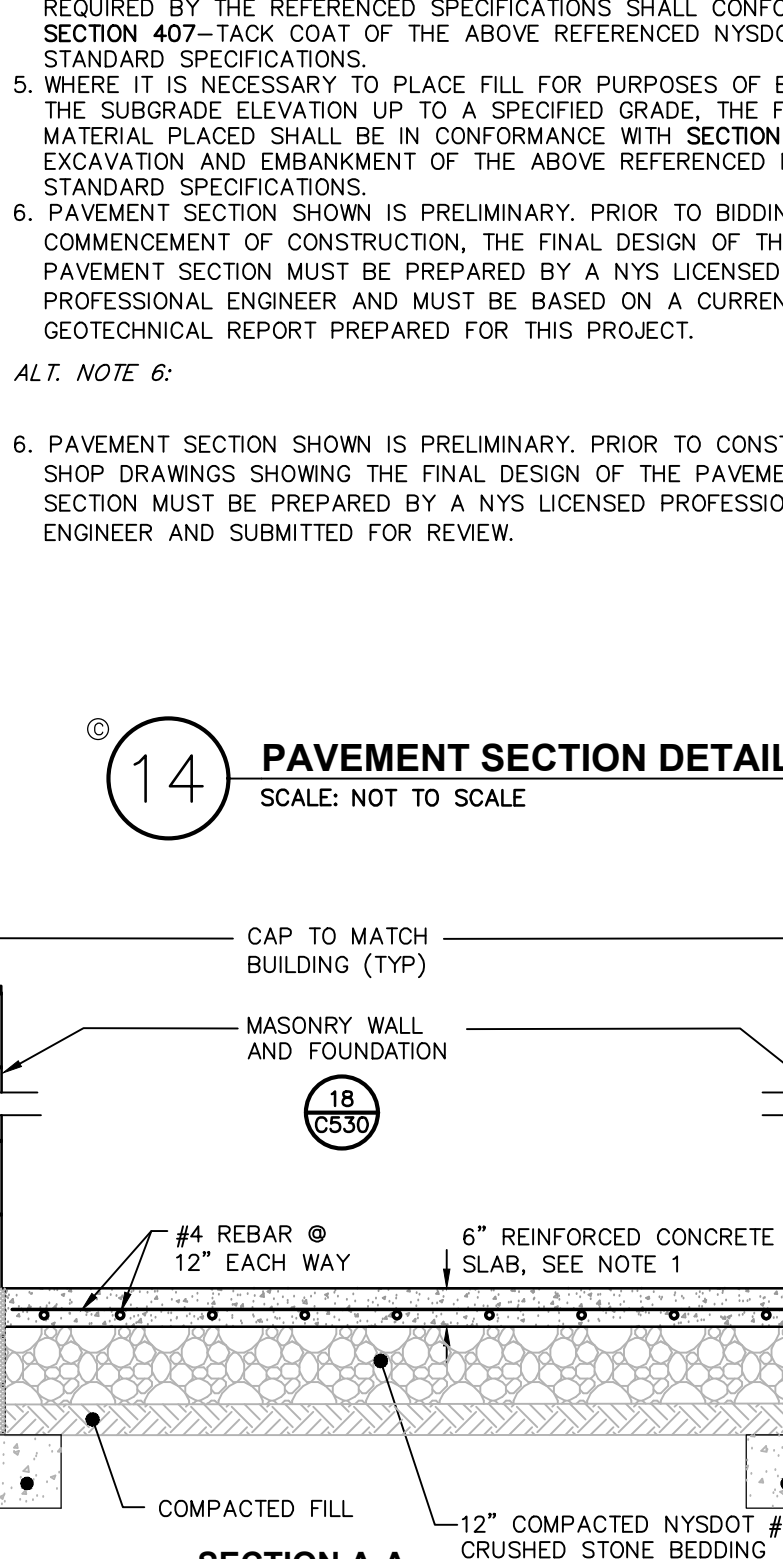
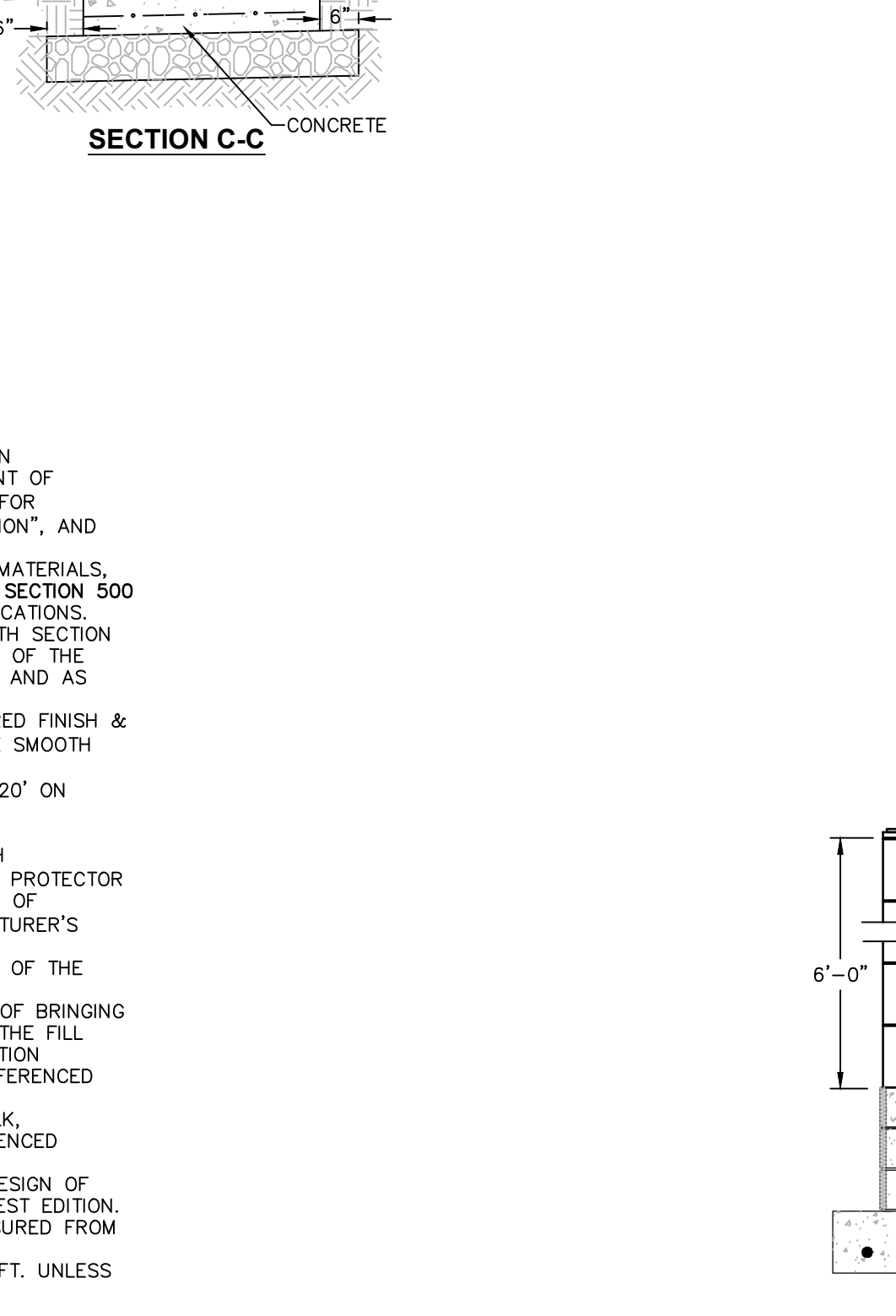
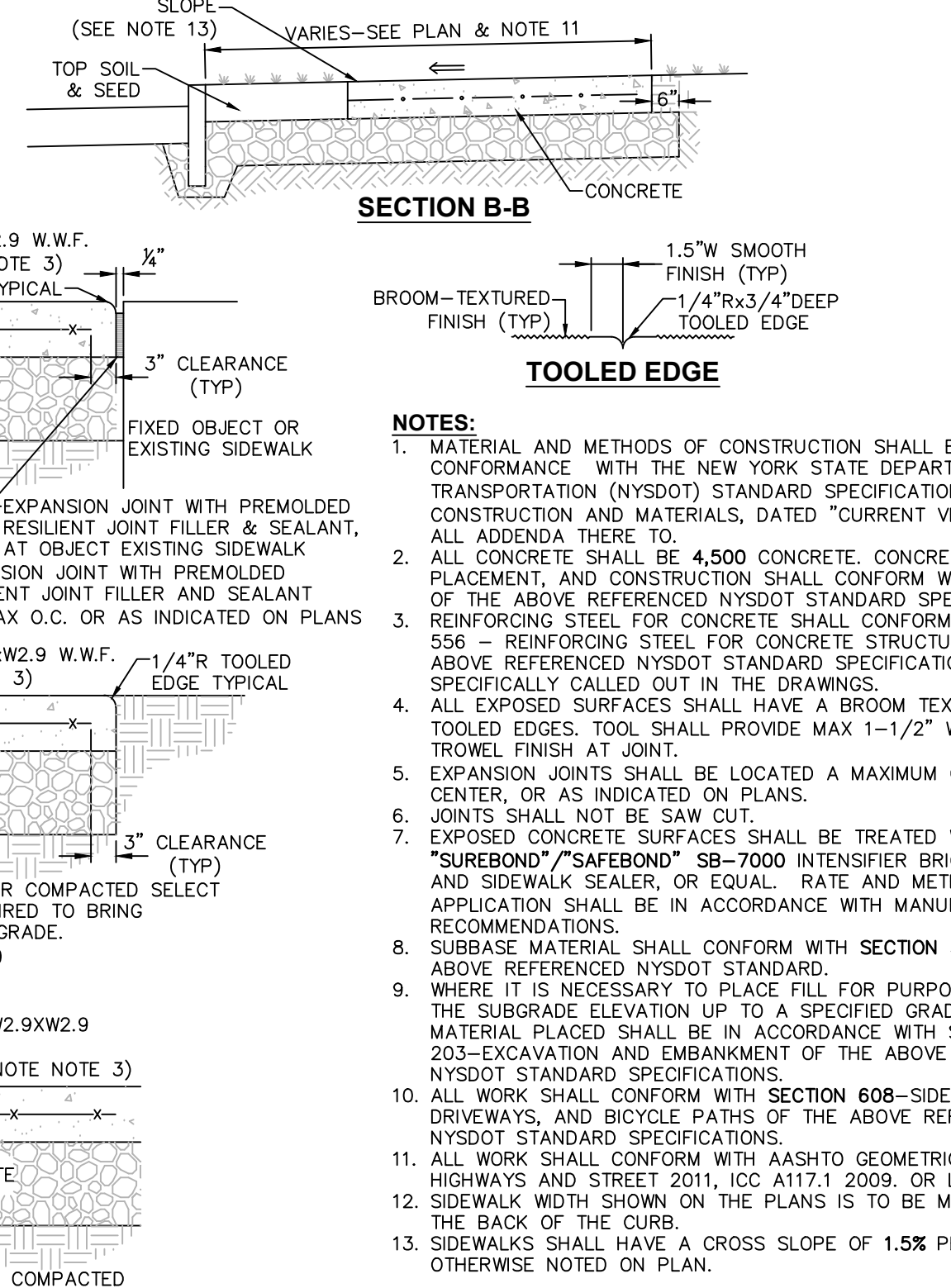
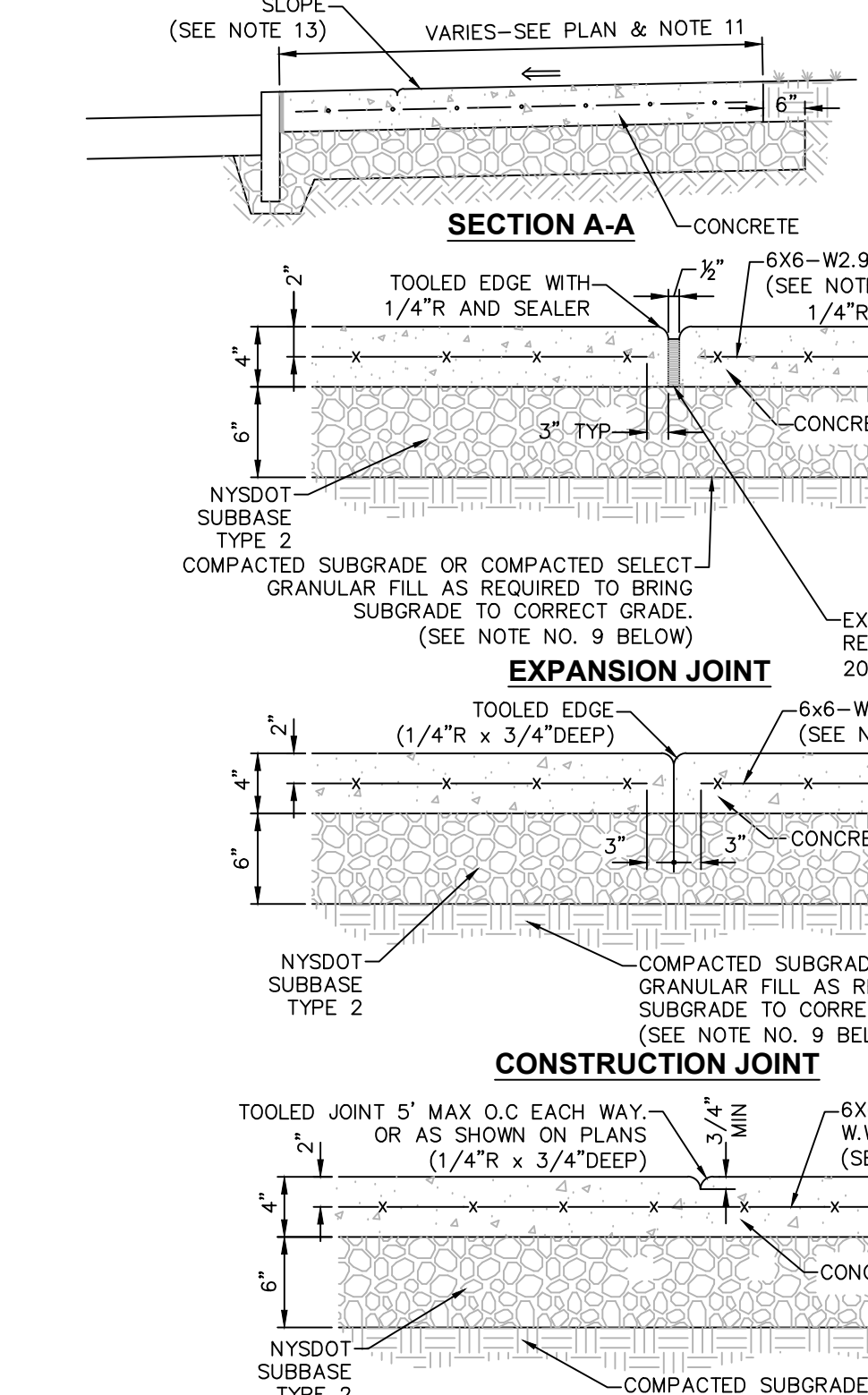
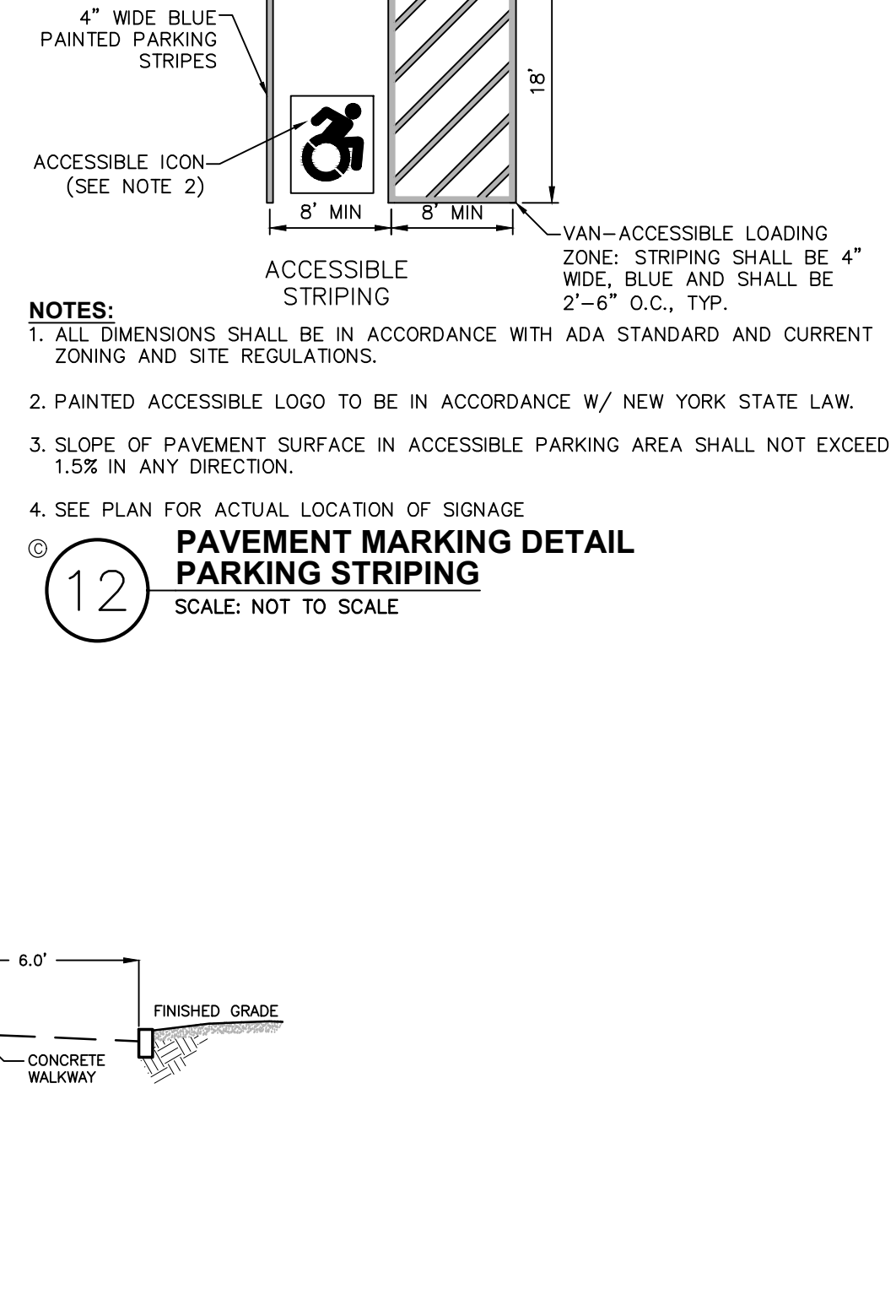
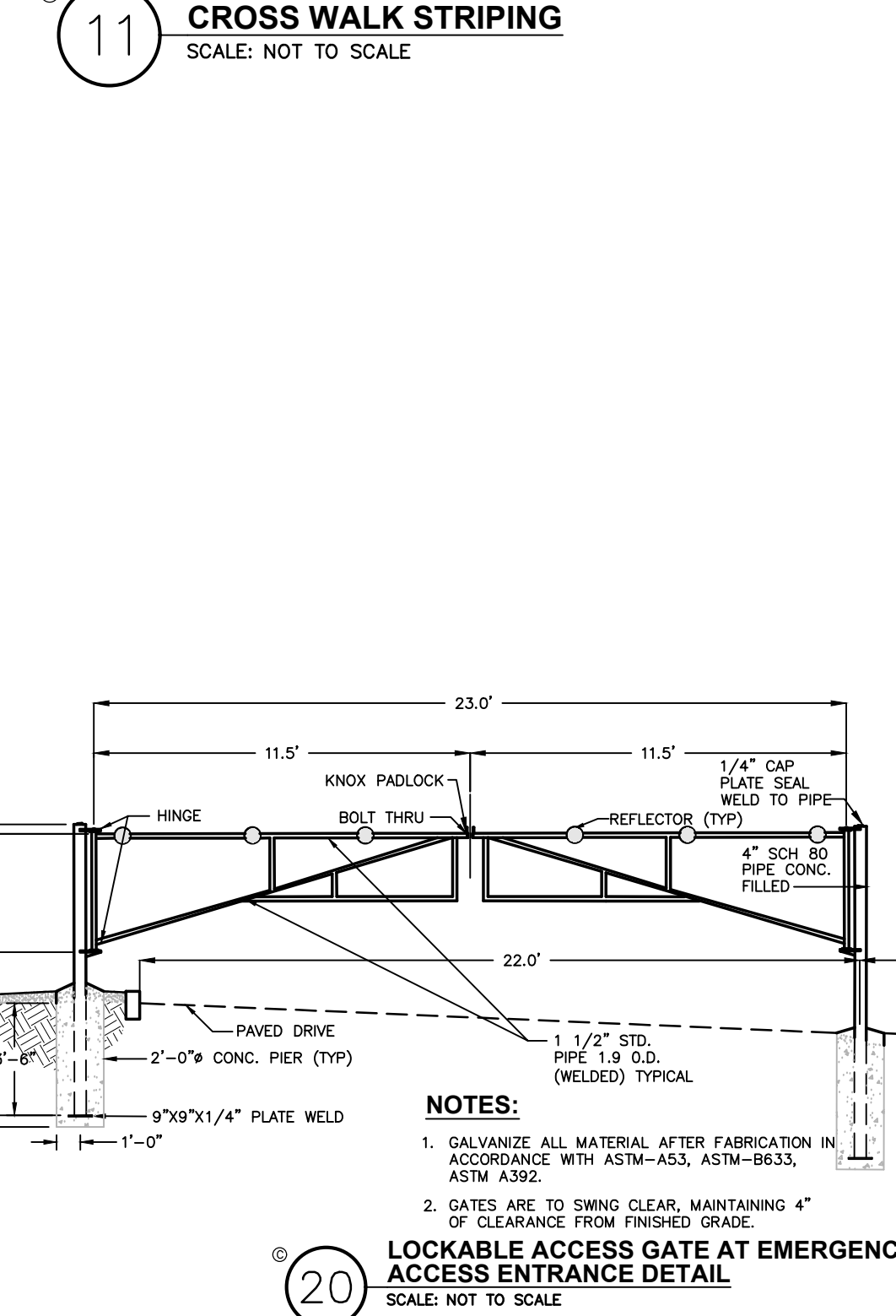
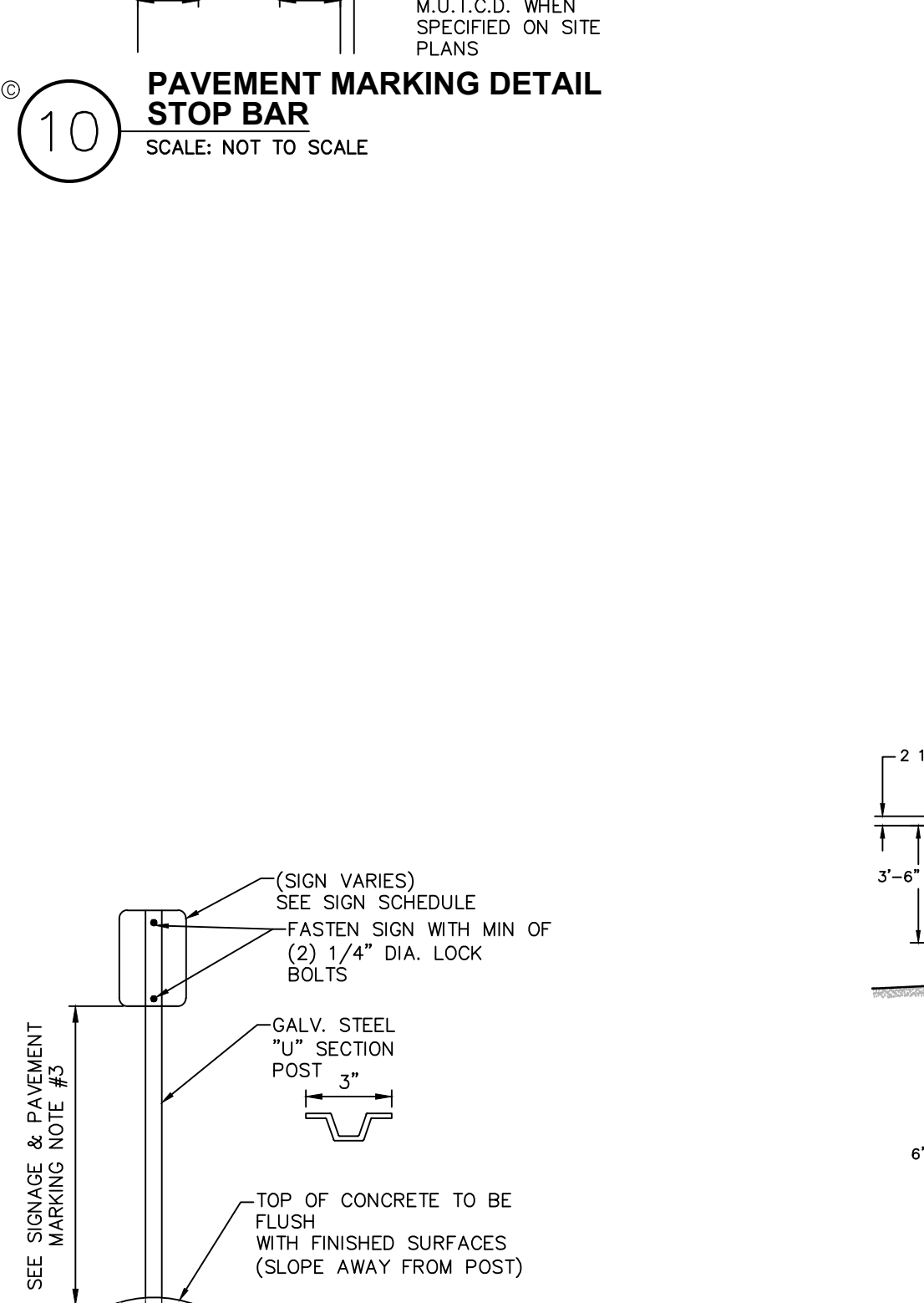

Dig Safely. New York.

Call Before You Dig
Mark the Unmarked
Control Utility Response
Request The Marks
Dig with Confidence
800-962-7962
www.digsafely.com

CHAZEN ENGINEERING, LAND SURVEYING

Office Locations:
 North Coast Office: 20 Elm Street, Suite 110, Glen Falls, NY 12041
 Northville Office: 207 S. 5th St., Suite 201, Chautauque, NY 13603
 Westchester Office: 1 North Broadway, Suite 803, White Plains, NY 10601
 Long Island Office: 1000 N. Ave. 108, Suite 101, Great Neck, NY 11021

CHAZEN ENGINEERING, LAND SURVEYING & LANDSCAPE ARCHITECTURE CO., D.P.C.

Office Locations:
 Northville Office: 2418 2nd Ave. S., Suite 103, Northville, MI 48168
 Chautauque Office: 207 S. 5th St., Suite 201, Chautauque, NY 13603
 Westchester Office: 1 North Broadway, Suite 803, White Plains, NY 10601
 Long Island Office: 1000 N. Ave. 108, Suite 101, Great Neck, NY 11021

CHAZEN ENGINEERING, LAND SURVEYING & LANDSCAPE ARCHITECTURE CO., D.P.C.

Office Locations:
 Northville Office: 2418 2nd Ave. S., Suite 103, Northville, MI 48168
 Chautauque Office: 207 S. 5th St., Suite 201, Chautauque, NY 13603
 Westchester Office: 1 North Broadway, Suite 803, White Plains, NY 10601
 Long Island Office: 1000 N. Ave. 108, Suite 101, Great Neck, NY 11021

CHAZEN ENGINEERING, LAND SURVEYING & LANDSCAPE ARCHITECTURE CO., D.P.C.

Office Locations:
 Northville Office: 2418 2nd Ave. S., Suite 103, Northville, MI 48168
 Chautauque Office: 207 S. 5th St., Suite 201, Chautauque, NY 13603
 Westchester Office: 1 North Broadway, Suite 803, White Plains, NY 10601
 Long Island Office: 1000 N. Ave. 108, Suite 101, Great Neck, NY 11021

CHAZEN ENGINEERING, LAND SURVEYING & LANDSCAPE ARCHITECTURE CO., D.P.C.

Office Locations:
 Northville Office: 2418 2nd Ave. S., Suite 103, Northville, MI 48168
 Chautauque Office: 207 S. 5th St., Suite 201, Chautauque, NY 13603
 Westchester Office: 1 North Broadway, Suite 803, White Plains, NY 10601
 Long Island Office: 1000 N. Ave. 108, Suite 101, Great Neck, NY 11021

CHAZEN ENGINEERING, LAND SURVEYING & LANDSCAPE ARCHITECTURE CO., D.P.C.

Office Locations:
 Northville Office: 2418 2nd Ave. S., Suite 103, Northville, MI 48168
 Chautauque Office: 207 S. 5th St., Suite 201, Chautauque, NY 13603
 Westchester Office: 1 North Broadway, Suite 803, White Plains, NY 10601
 Long Island Office: 1000 N. Ave. 108, Suite 101, Great Neck, NY 11021

CHAZEN ENGINEERING, LAND SURVEYING & LANDSCAPE ARCHITECTURE CO., D.P.C.

Office Locations:
 Northville Office: 2418 2nd Ave. S., Suite 103, Northville, MI 48168
 Chautauque Office: 207 S. 5th St., Suite 201, Chautauque, NY 13603
 Westchester Office: 1 North Broadway, Suite 803, White Plains, NY 10601
 Long Island Office: 1000 N. Ave. 108, Suite 101, Great Neck, NY 11021