

SEWER DETAILS

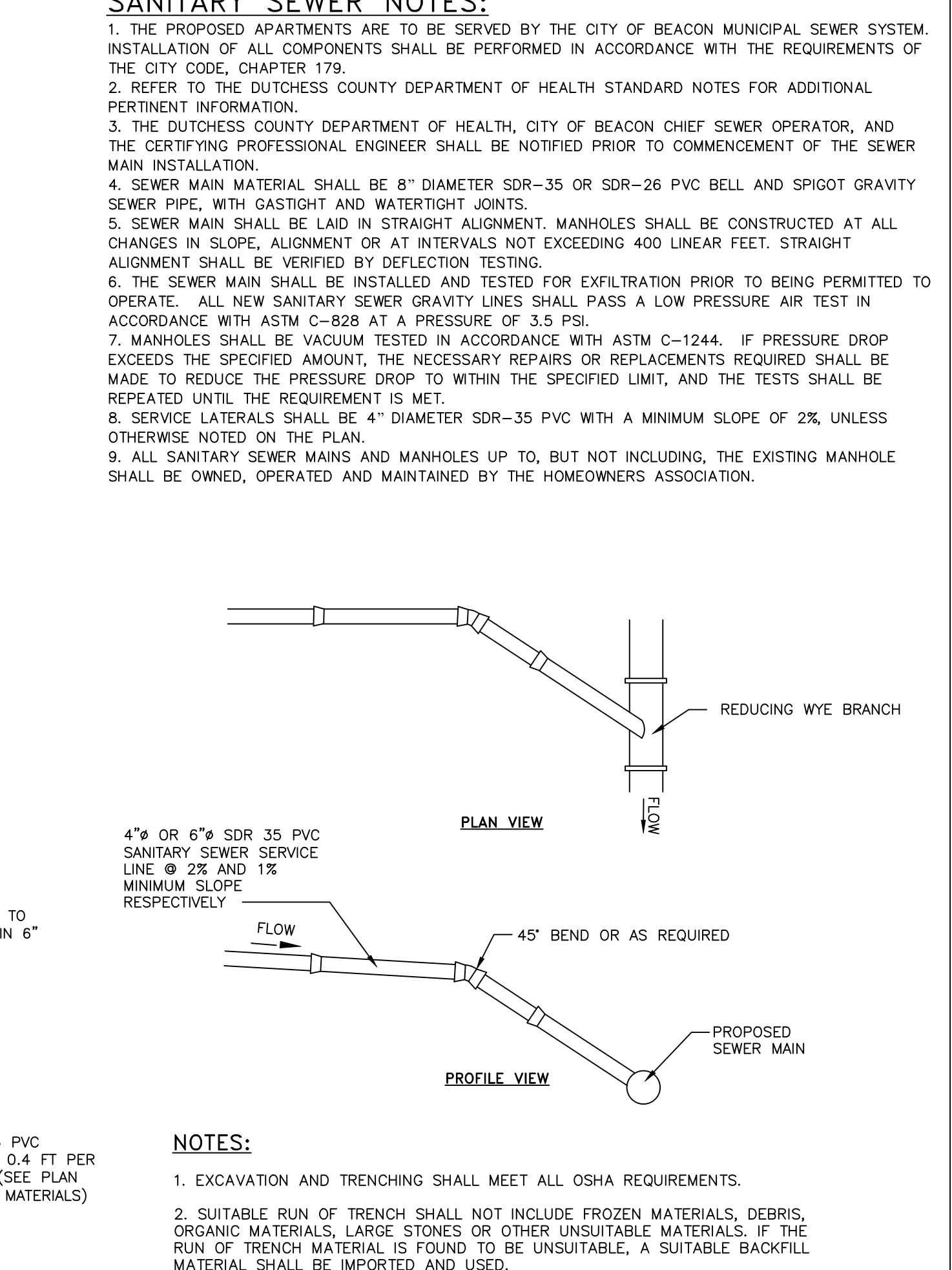
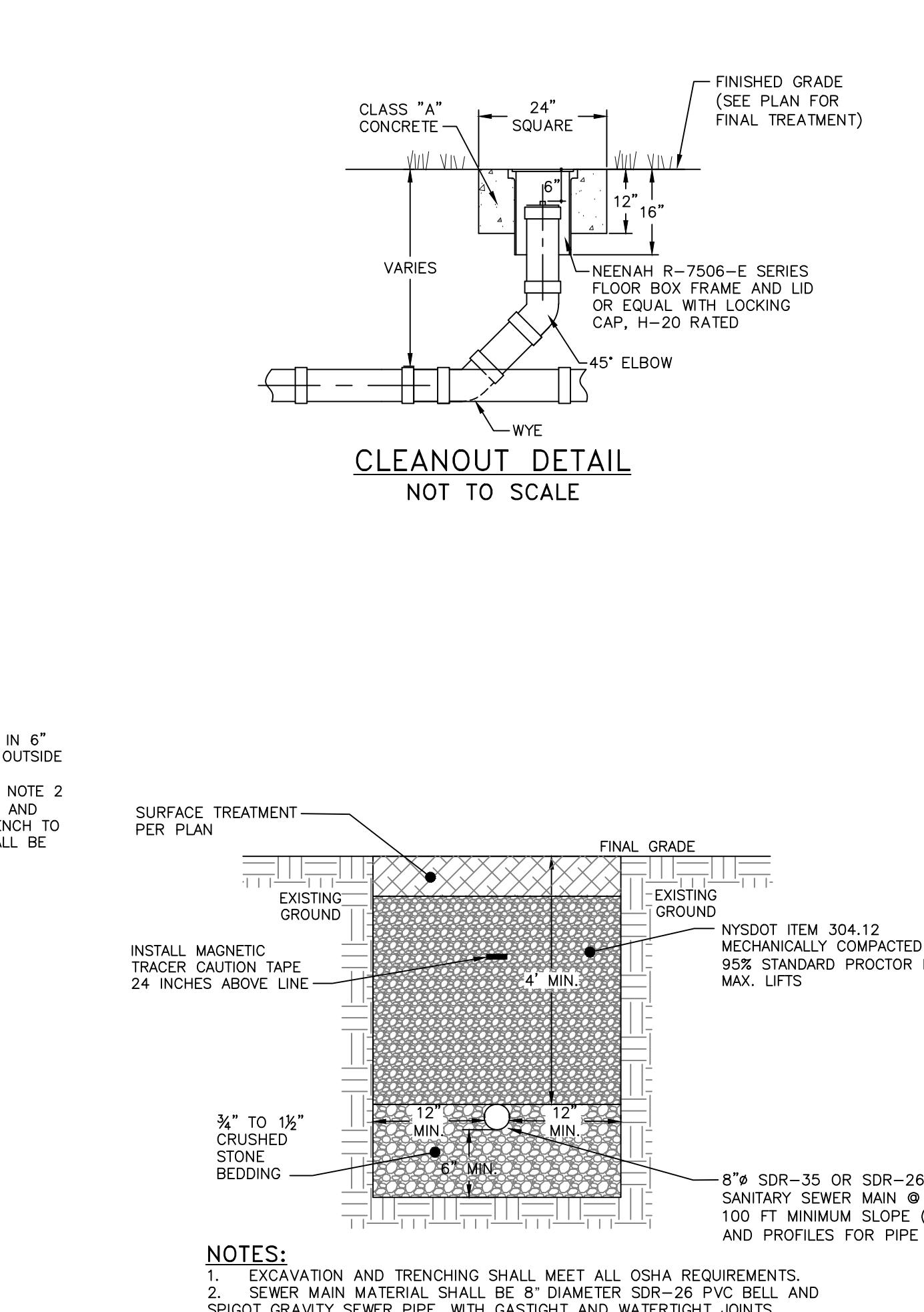
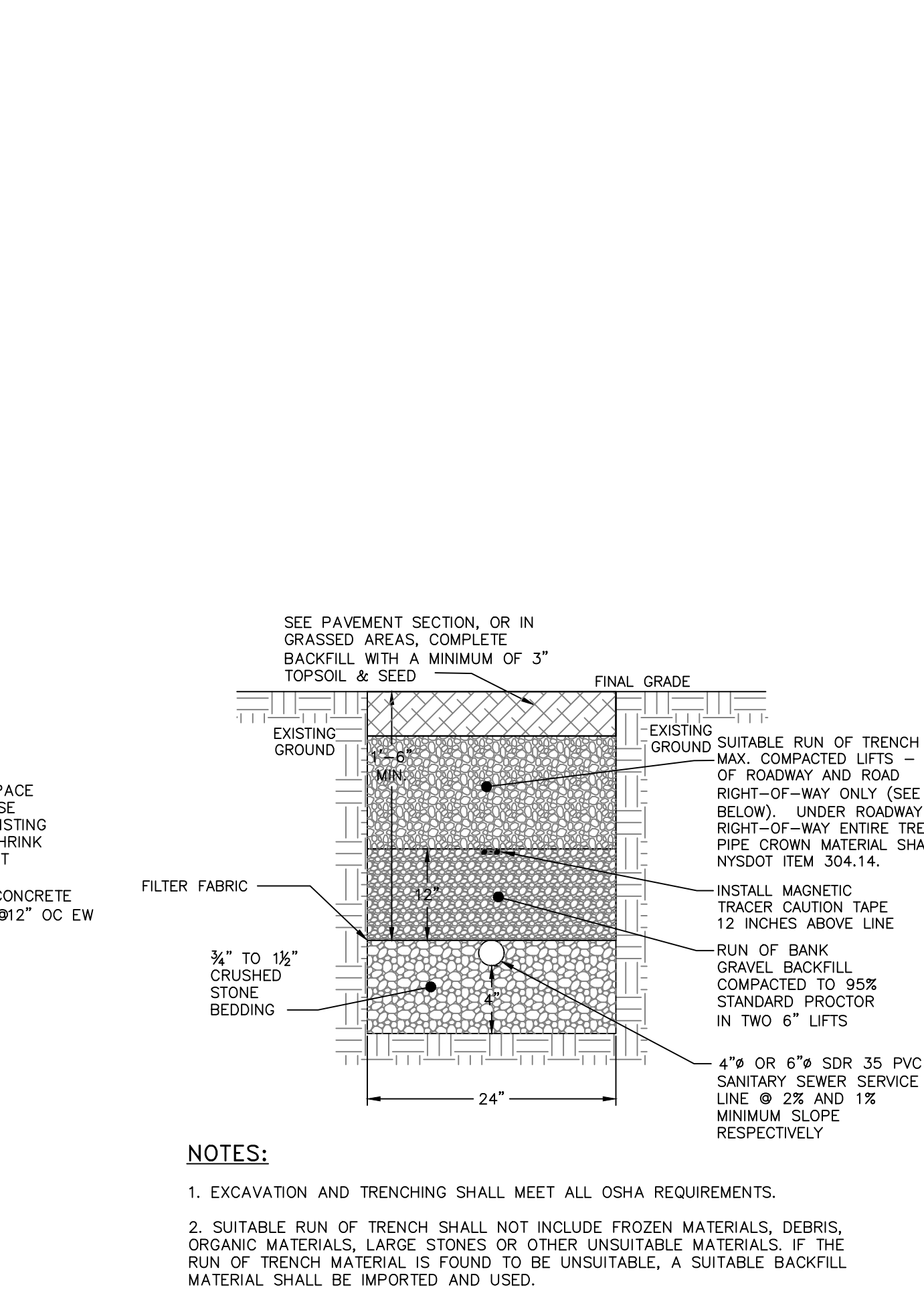
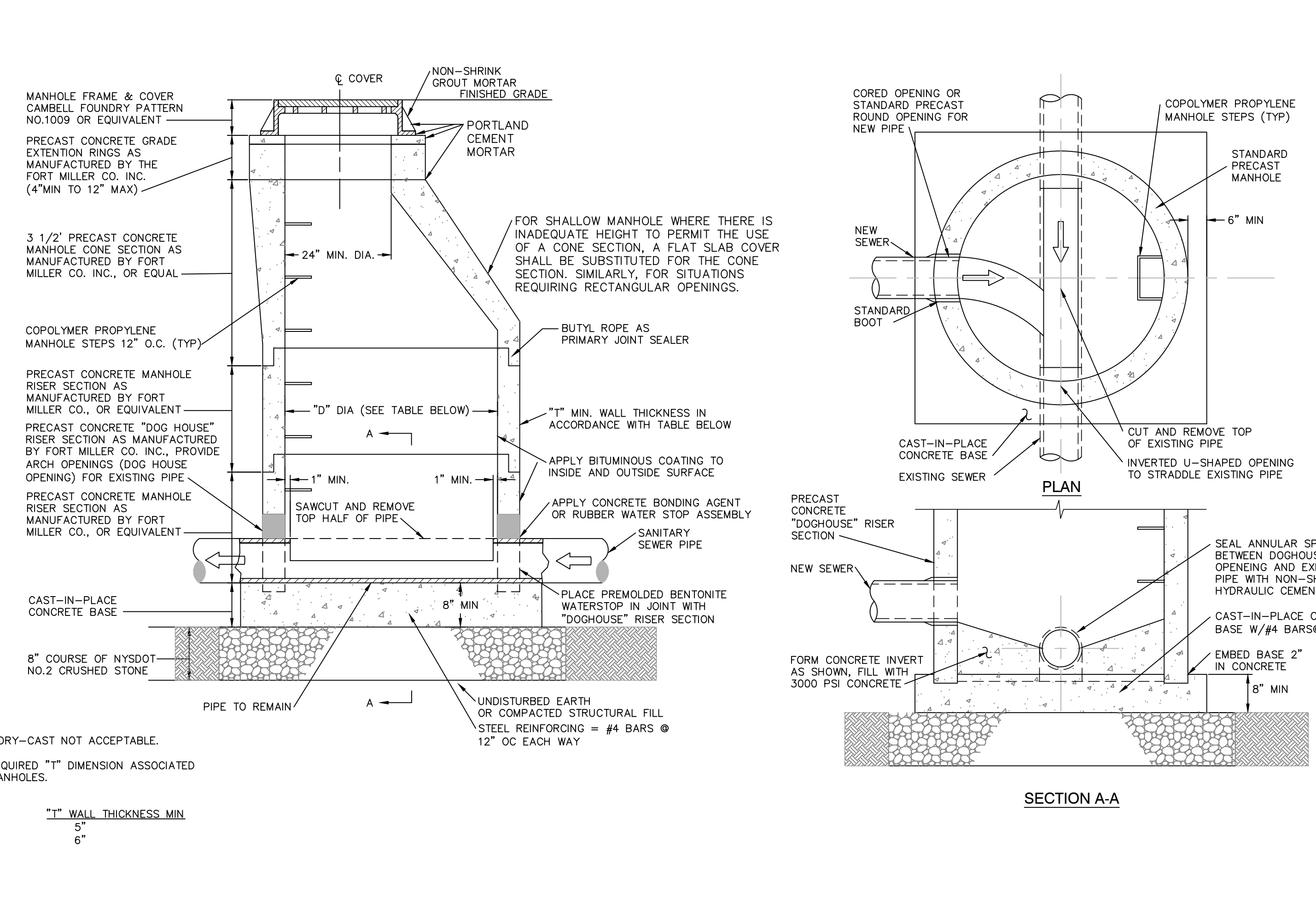
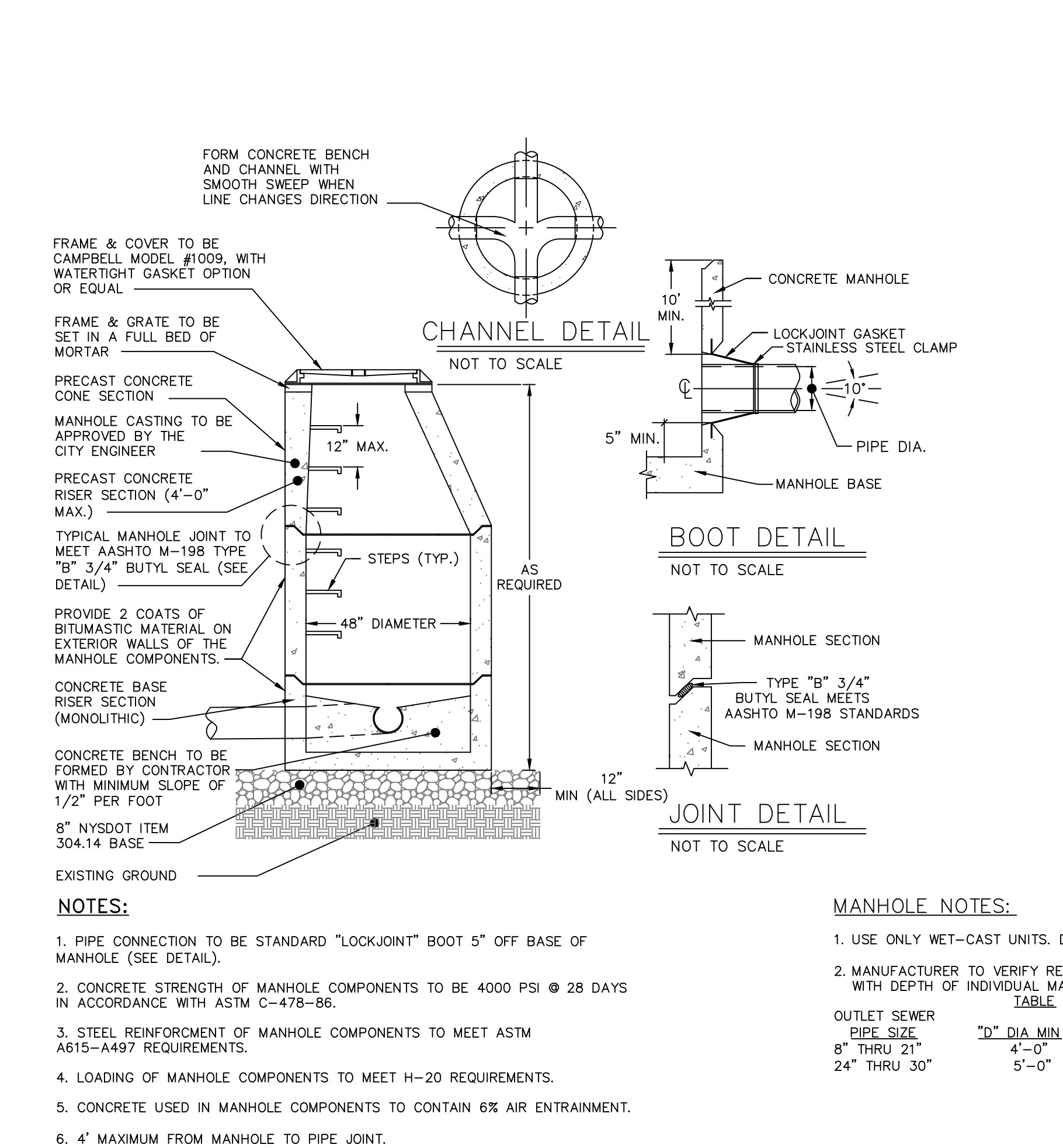

PRE-CAST CONCRETE SANITARY MANHOLE DETAIL
NOT TO SCALE

PRECAST CONCRETE INSERTION "DOGHOUSE" MANHOLE DETAIL
NOT TO SCALE

SANITARY SEWER SERVICE LINE TRENCH DETAIL
NOT TO SCALE

SANITARY SEWER MAIN TRENCH DETAIL
NOT TO SCALE

SANITARY SEWER SERVICE CONNECTION DETAIL
NOT TO SCALE

WATER DETAILS

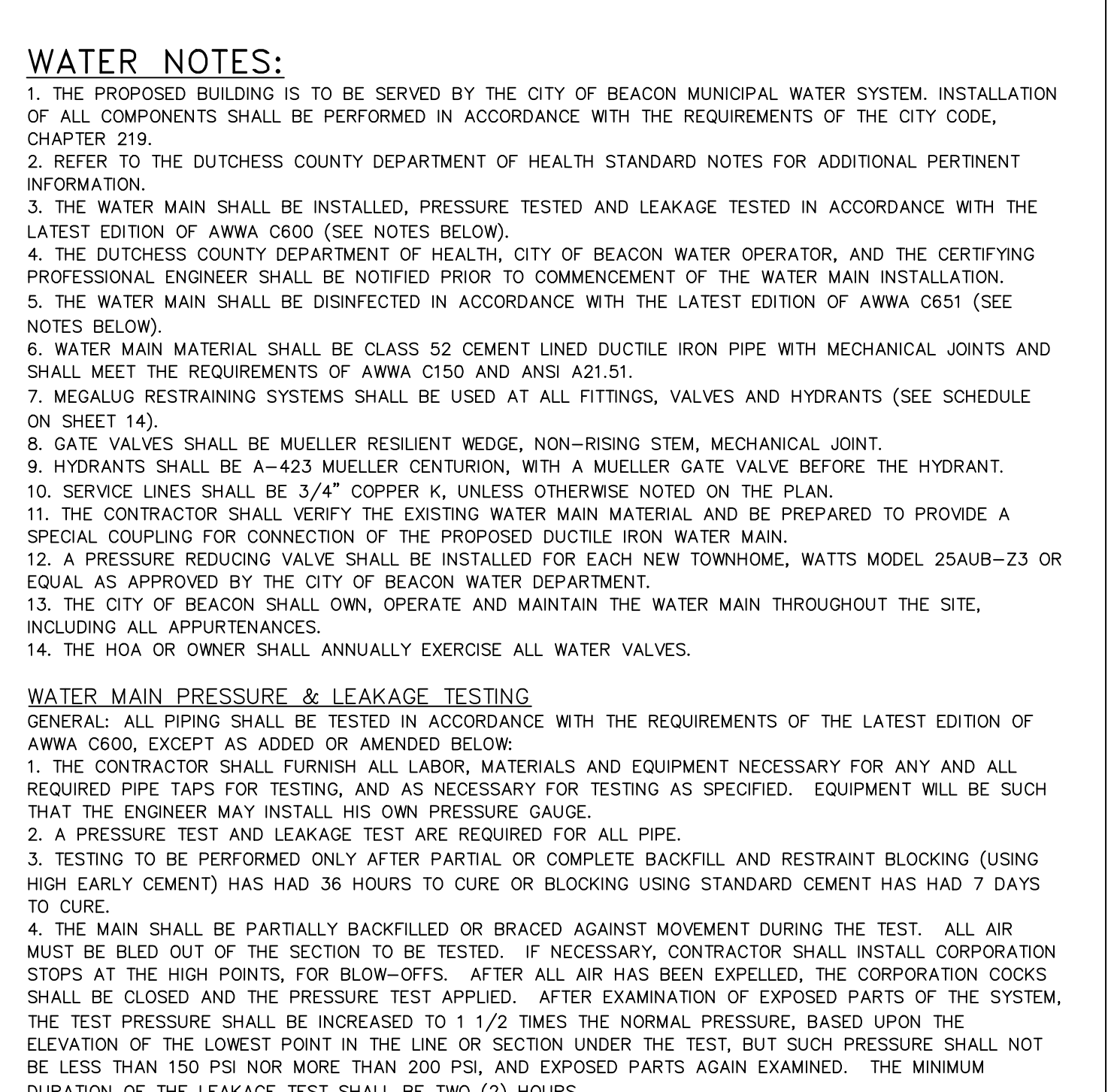
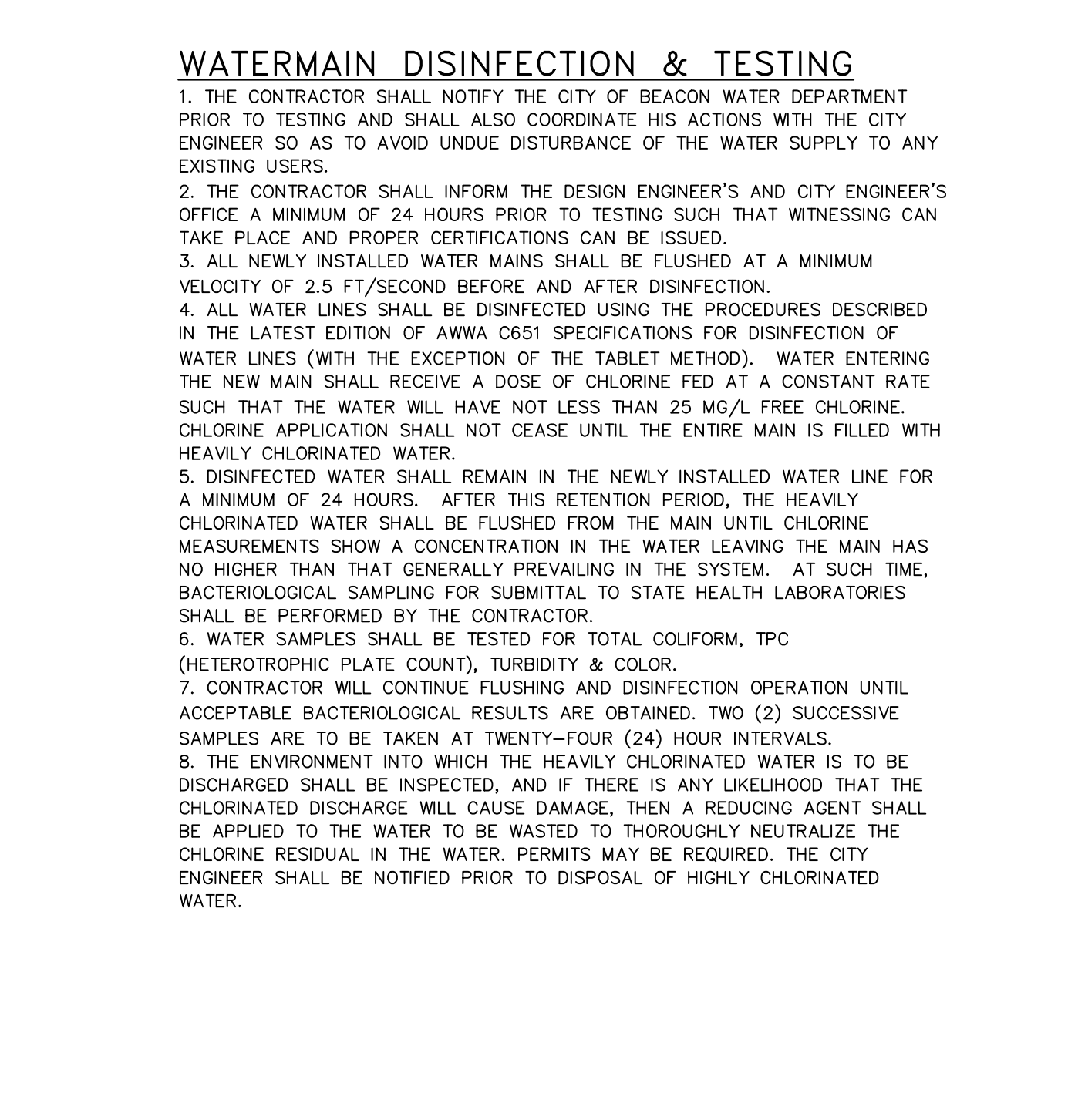
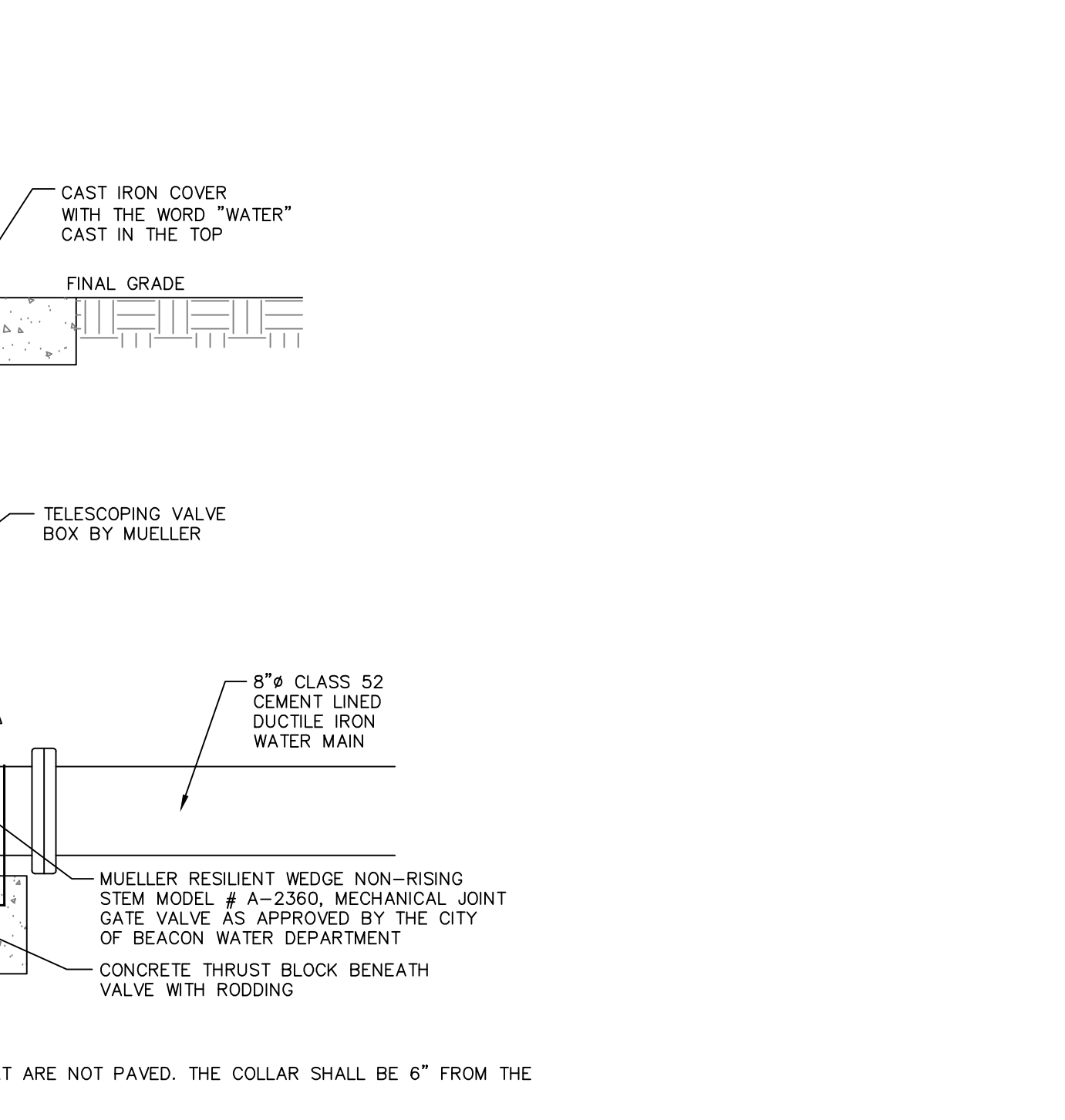
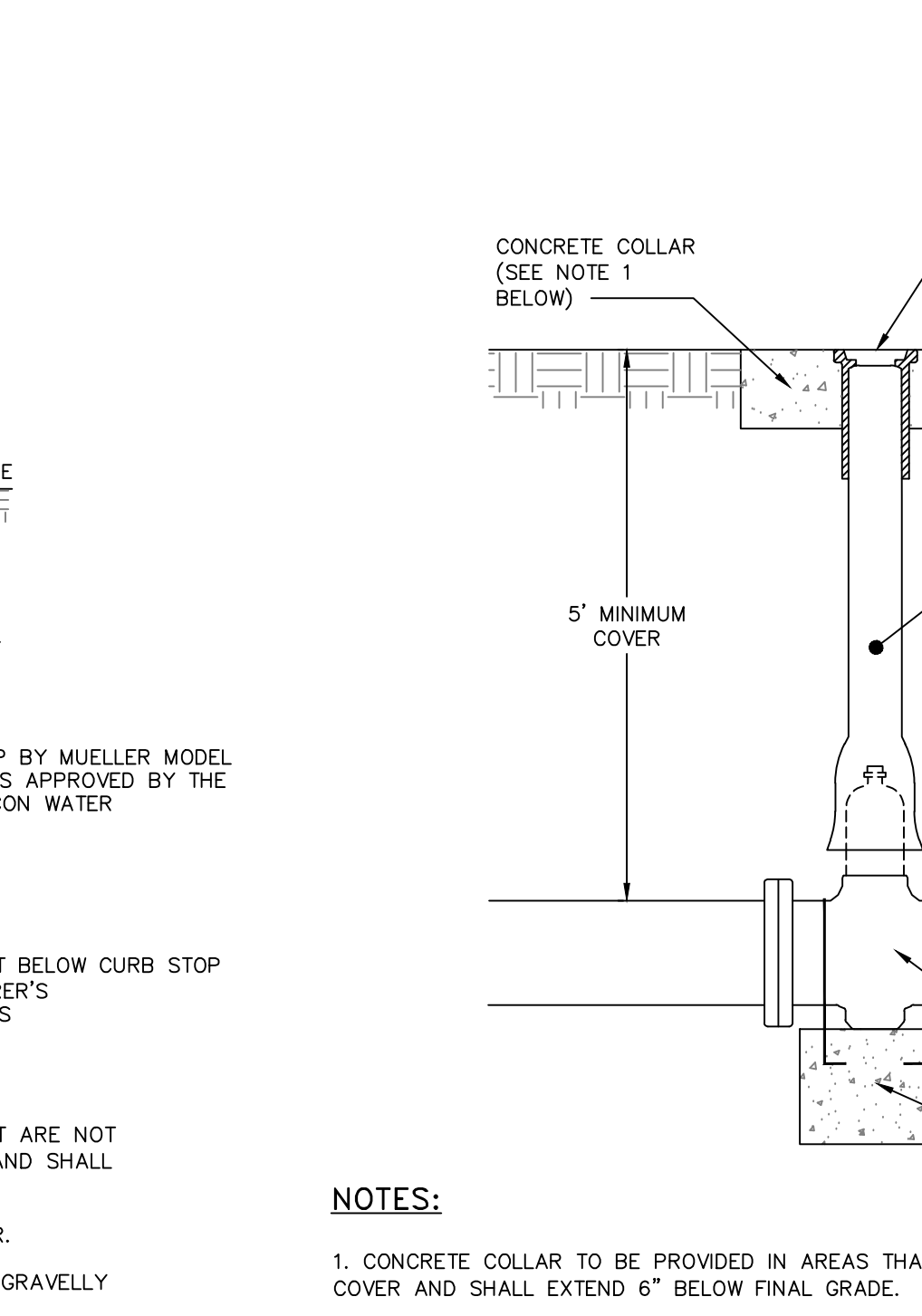
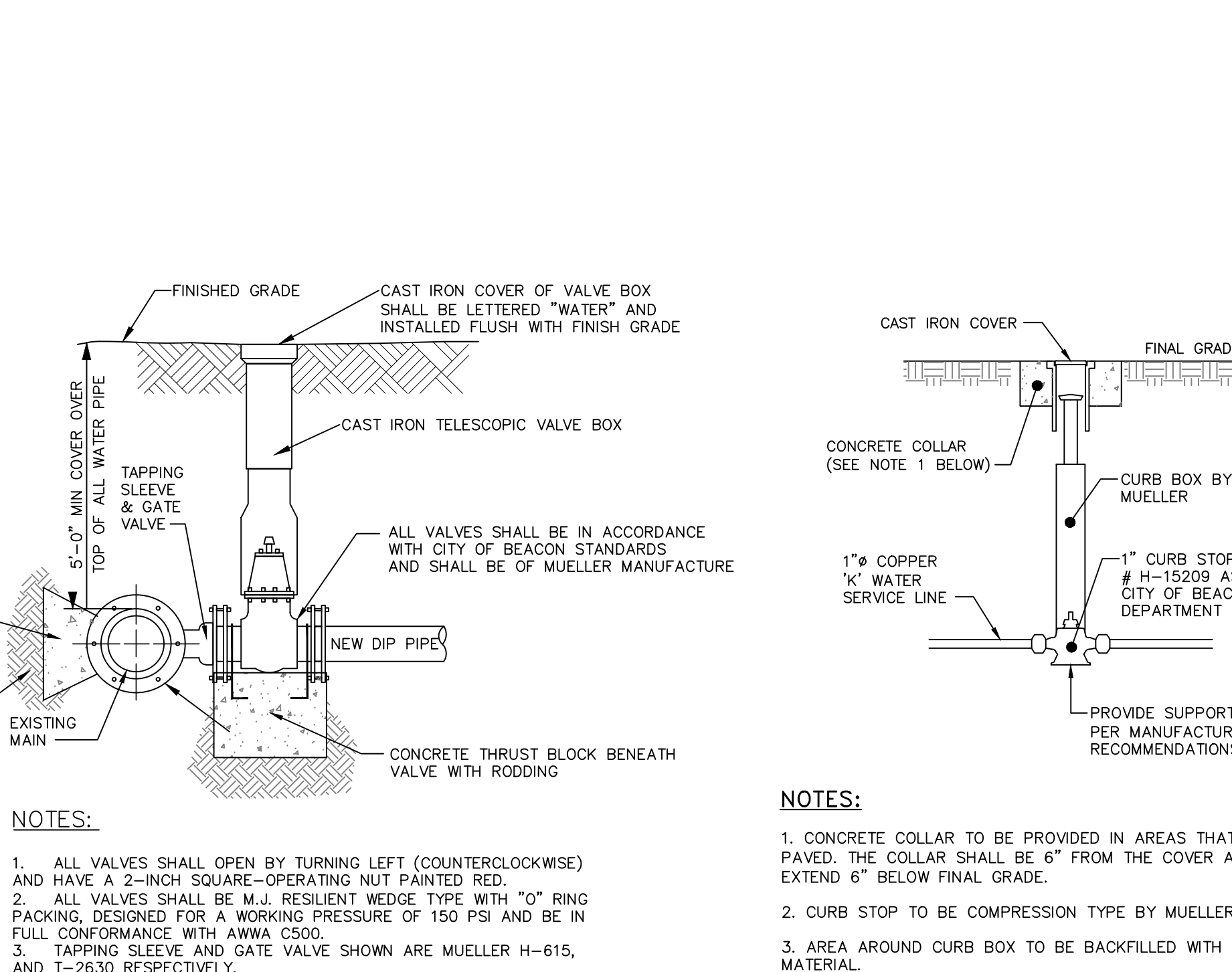
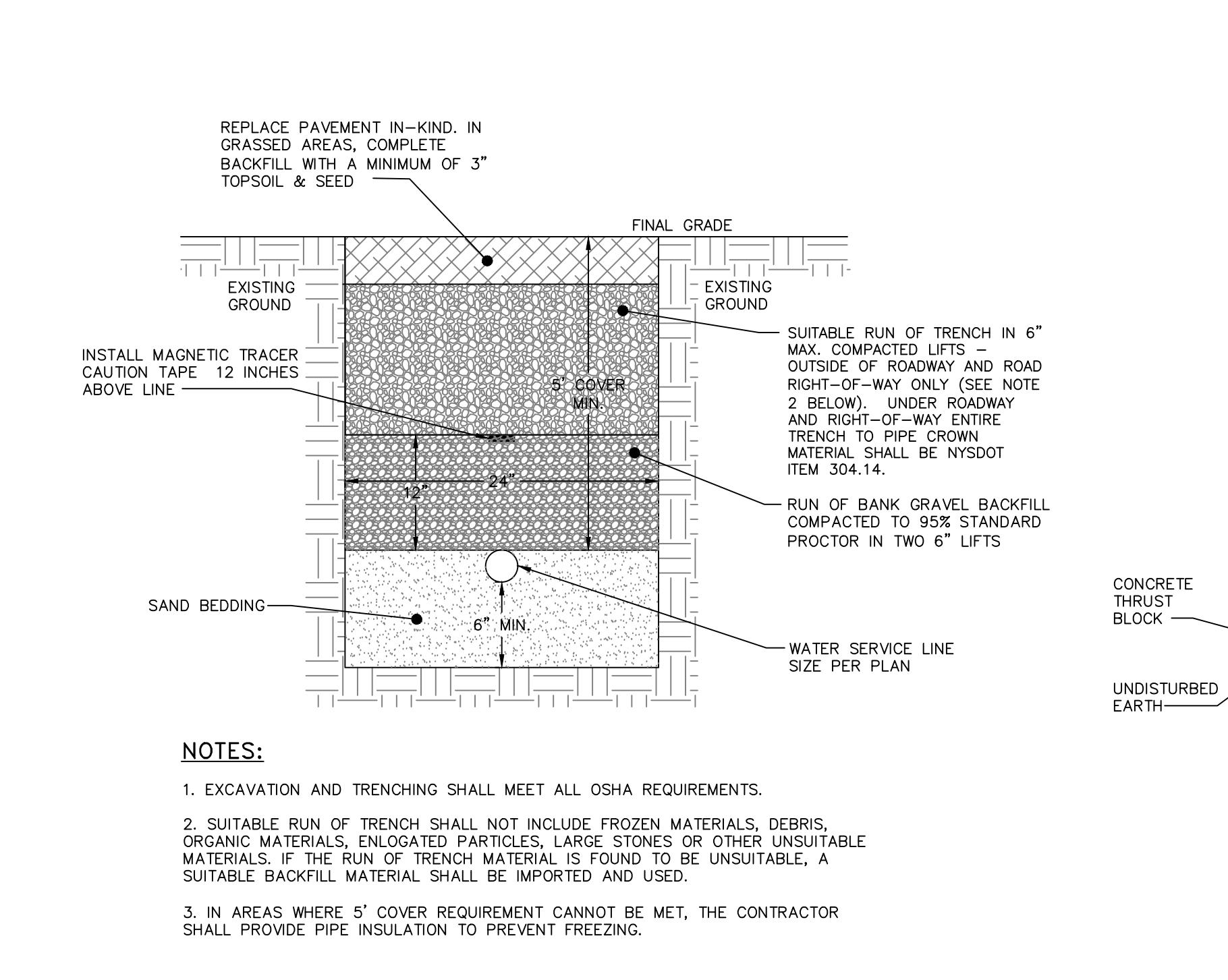

WATER SERVICE LINE TRENCH DETAIL
NOT TO SCALE

TAPPING SLEEVE DETAIL
NOT TO SCALE

WATER SHUT-OFF VALVE DETAIL
NOT TO SCALE

GATE VALVE DETAIL
NOT TO SCALE

WATER SERVICE CONNECTION DETAIL
NOT TO SCALE

WATER MAIN TRENCH DETAIL
NOT TO SCALE

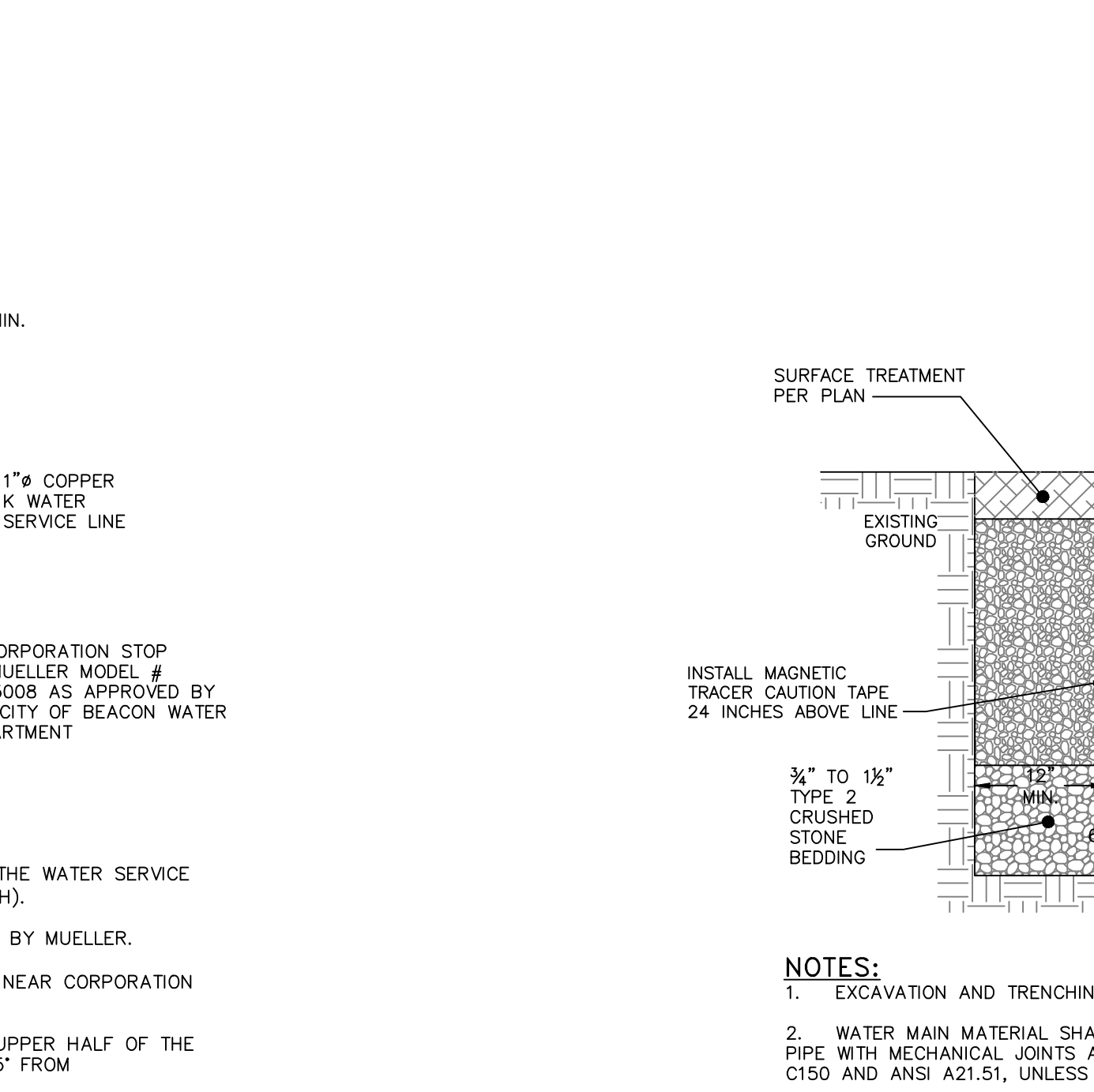
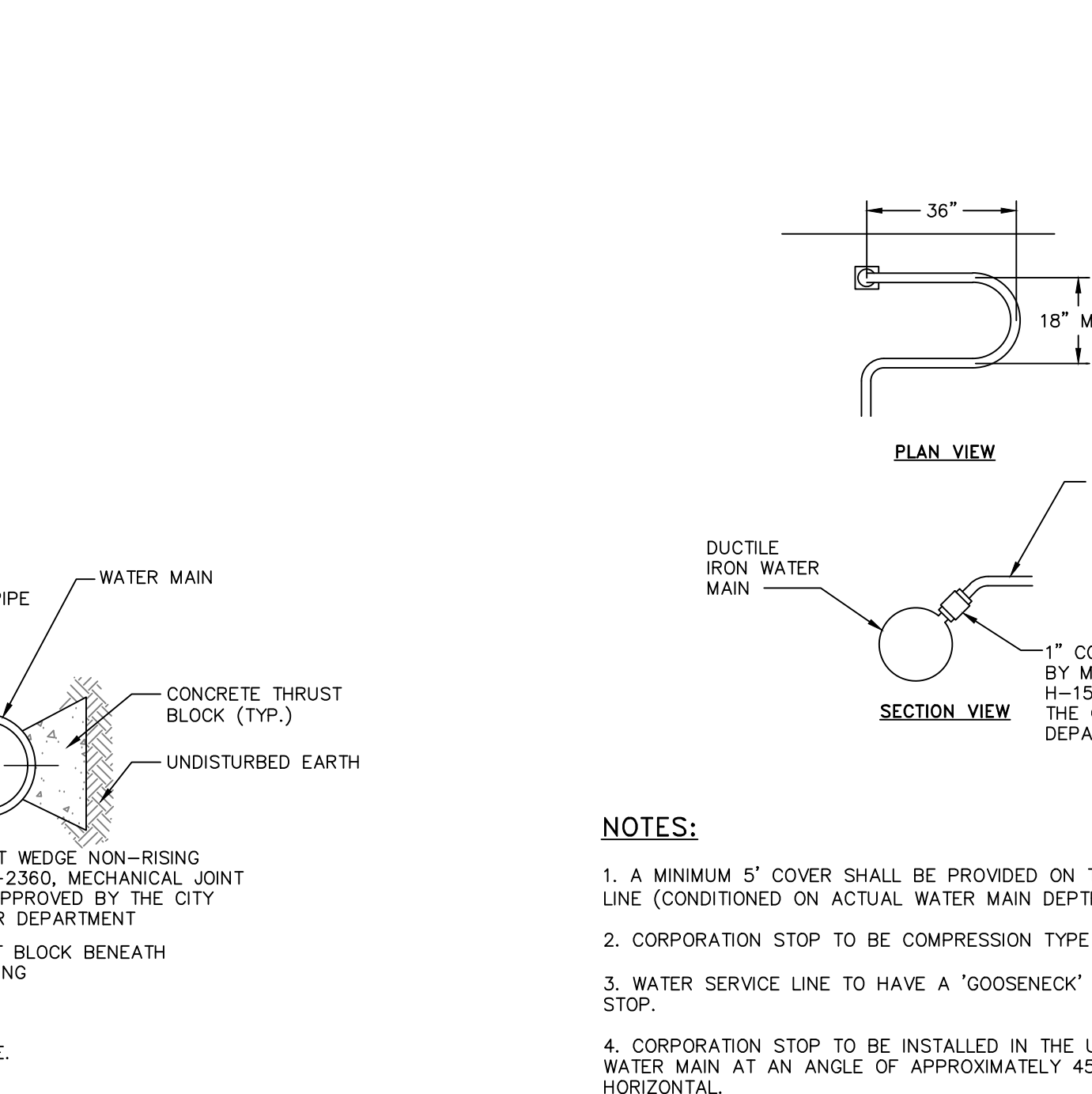
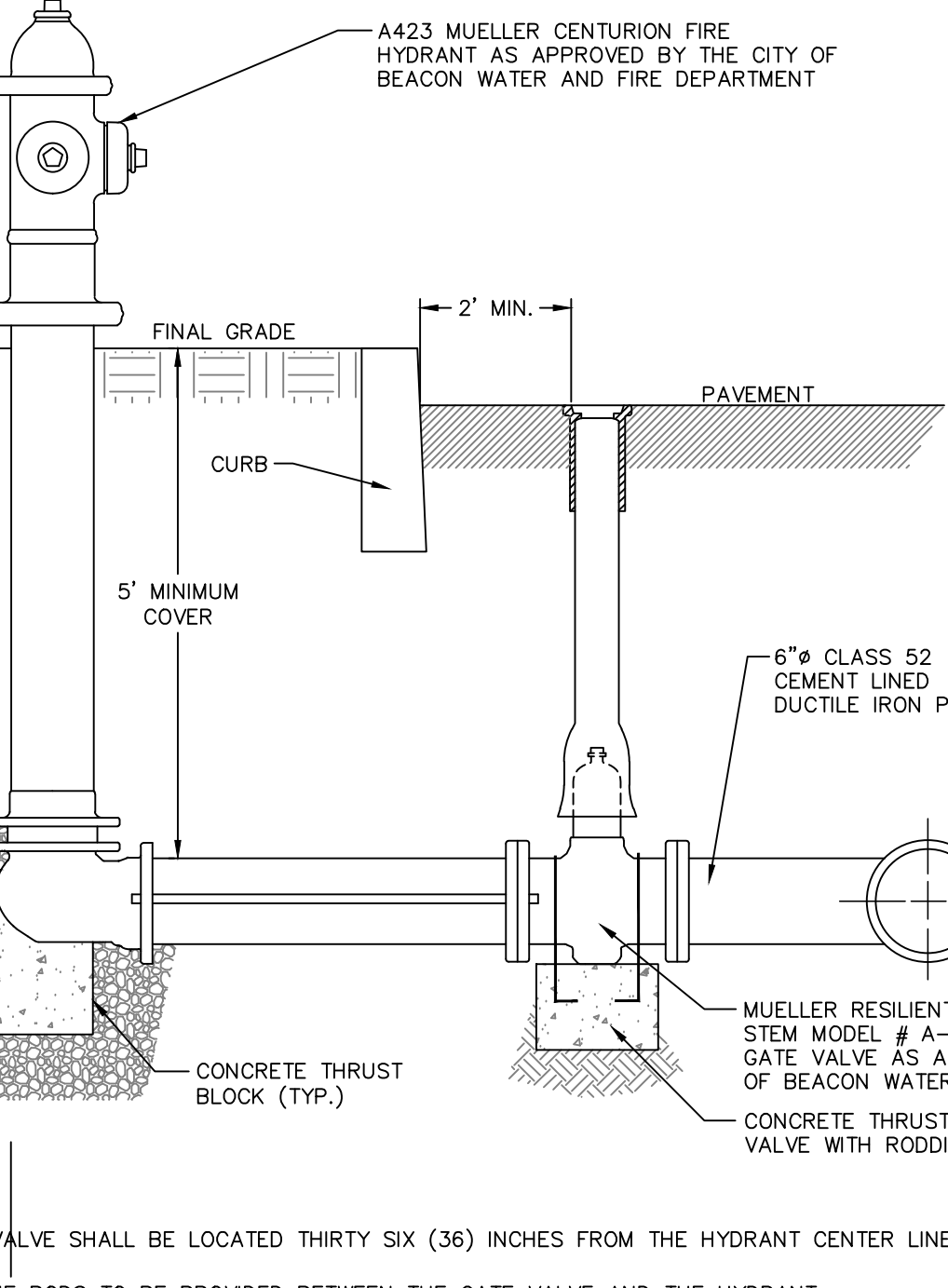
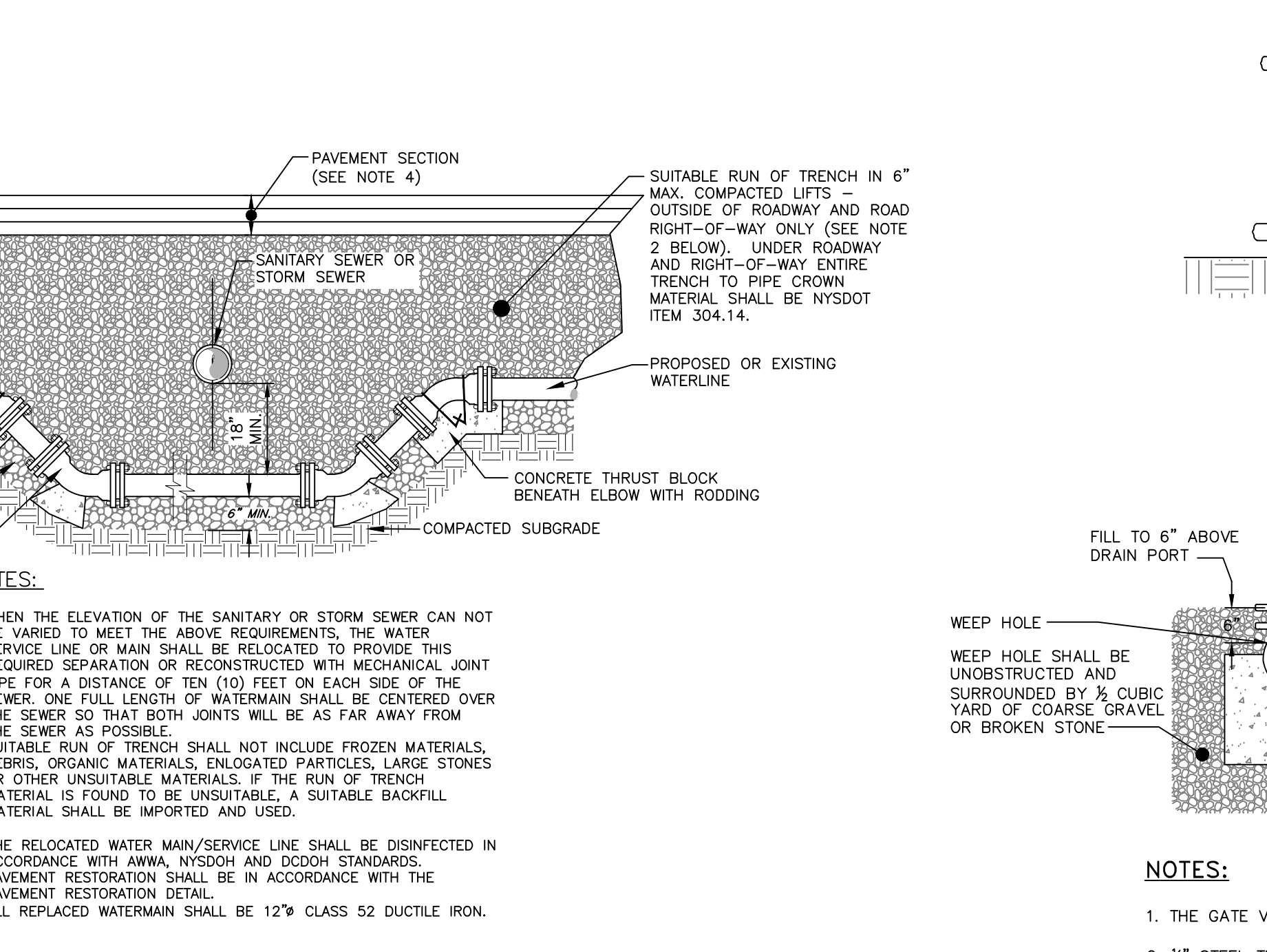
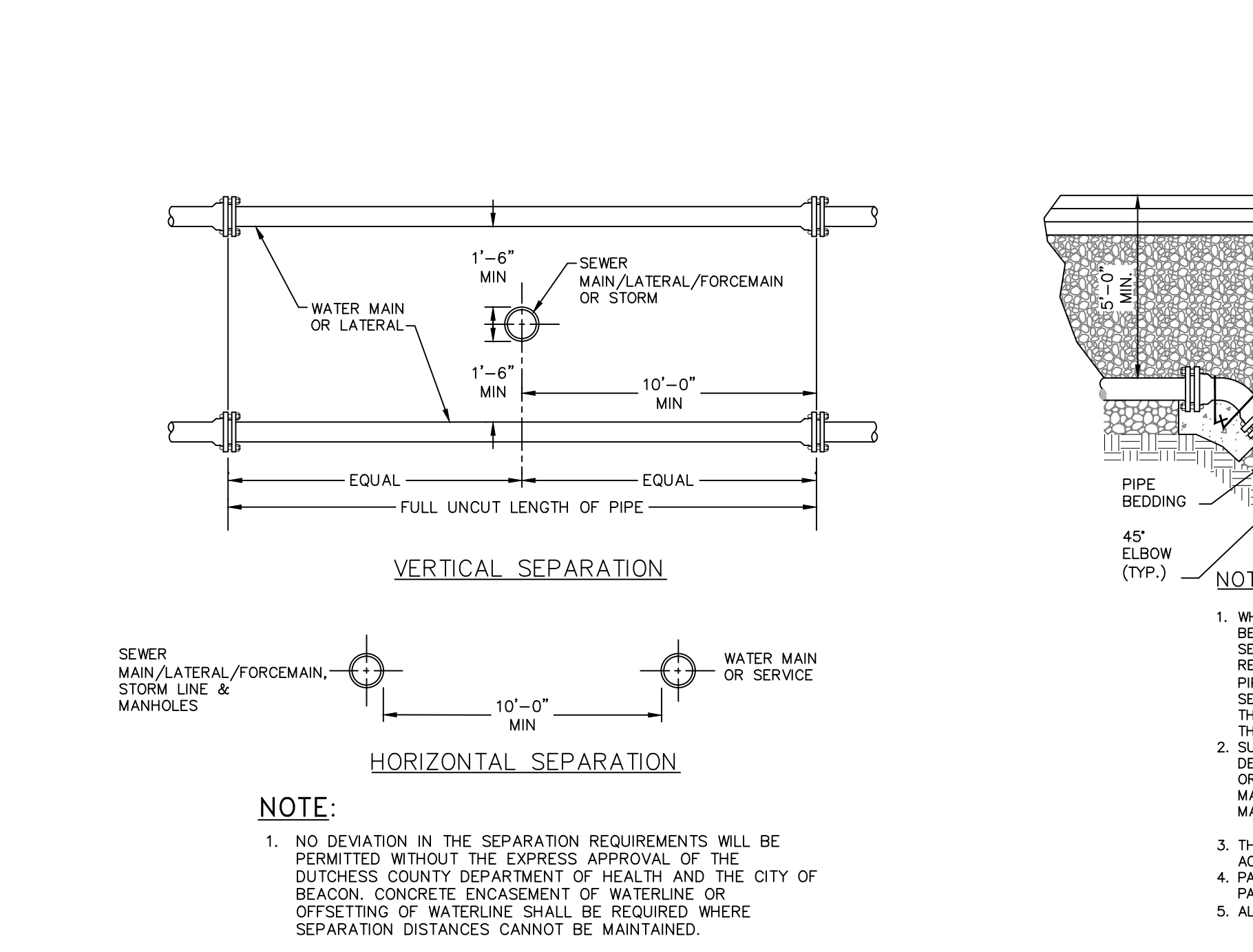

WATER LINE SEPARATION DETAIL
NOT TO SCALE

WATER LINE OFFSET DETAIL
NOT TO SCALE

HYDRANT DETAIL
NOT TO SCALE

WATER SERVICE CONNECTION DETAIL
NOT TO SCALE

WATER MAIN TRENCH DETAIL
NOT TO SCALE

DRAWN BY: MAB			CHECKED BY: DKG				
REVISIONS:			REVISIONS:				
NO.	DATE	DESCRIPTION	BY	NO.	DATE	DESCRIPTION	BY
1	12/25/16	REVISED FOR PLANNING BOARD SUBMISSION	MAB	7	12/31/19	NO CHANGE THIS SHEET	CMB
2	02/28/19	REVISED FOR PLANNING BOARD SUBMISSION	MAB				
3	03/29/19	NO CHANGE THIS SHEET	MAB				
4	04/25/19	REVISED PER PLANNING BOARD COMMENTS	MAB				
5	05/23/19	REVISED PER PLANNING BOARD COMMENTS	MAB				
6	10/29/19	NO CHANGE THIS SHEET	CMB				

Dig Safely. New York
800-962-7962
www.digsafelynewyork.com

HUDSON LAND DESIGN

SEAL

HUDSON LAND DESIGN
PROFESSIONAL ENGINEERING P.C.
174 MAIN ST., BEACON, NEW YORK 12508
13 CHAMBERS ST., NEWBURGH, NEW YORK 12550
PH: 845-440-6920
F: 845-440-6637

WATER AND SEWER DETAILS

23-28 CREEK DRIVE

23-28 CREEK ROAD
CITY OF BEACON
DUTCHESS COUNTY, NEW YORK
TAX ID: 6054-37-037825

JOB #:	2018-029
DATE:	10/23/2018
SCALE:	AS SHOWN
TITLE:	D-3
SHEET:	12 OF 12